



Barryvox[®] S2

EXTENDED REFERENCE MANUAL

October 2024



Switzerland (Head Office)

Mammut Sports Group AG
Birren 5
CH-5703 Seon
+41 (0)62 769 81 81
info@mammut.com

Europe

Mammut Sports Group GmbH
Mammut Basecamp 1
DE-87787 Wolfertschwenden
+49 (0)8334 3620 0
germany@mammut.com

North America

Mammut Sports Group Inc.
458 Hurricane Lane
Williston, US-VT05495
+1 800 451 5127
info@mammutusa.com

mammut.com

The Extended Reference Guide contains hyperlinks and cross-references. To use these navigation functions, we recommend that you open the document with Adobe Acrobat Reader. These functions may not be available if you use your web browser to view the content.

The summary page gives you a quick and visual way of finding the information you need. Clicking on the icons on the summary page will take you to the relevant section.

Similarly clicking/tapping on a chapter or heading in the table of contents or on the underlined references in the text leads you to the relevant content in the manual. Clicking on the Mammut logo in the bottom righthand corner of each page will bring you back to the summary page.

Safety Instructions

Please note the following safety instructions and contact us if you have any questions or if you are not sure about anything.

The Barryvox® has been developed with maximum care and consideration for all safety-relevant factors. Nevertheless, the following potential risks remain:

- **Risk of losing the device if carried incorrectly:** Keep the Barryvox® in the intended carrying system or a secured bag and fasten it with the belay loop.
- **Risk of explosion due to incorrectly used batteries or damaged batteries, risk of incorrect capacity display due to improperly used batteries:** Only use alkaline (LR03/AAA) 1.5 V or lithium (L92/AAA) 1.5V batteries. Do not use damaged batteries.
- **Risk of malfunction or damage due to leaking batteries:** Remove batteries if the device will not be used for an extended period.
- **Risk of malfunction or damage due to extreme temperatures:** Protect the Barryvox® from extreme temperatures and direct sunlight during storage.
- **Risk of malfunction due to electronic devices (e.g., cell phones, radios, headlamps, cameras, sports watches), metal parts (e.g. pocketknives, magnetic buttons) or another search device in the immediate vicinity:** Keep your Barryvox® at least 20 cm away from such objects when on SEND and 50 cm away when on SEARCH, with electronic devices switched off.
- **Risk of pacemaker malfunction due to proximity of Barryvox®:** Follow the instructions of the respective manufacturer.

The Barryvox® Device



Learn your way around the device.



Power on and go through the set up process and wear the device



Discover the Barryvox® App and it's key functionality



Maintain and Service your Barryvox®

Using the Barryvox® on Tour



Learn how transceivers work

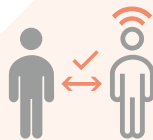

Learn how to perform a group transceiver check



Troubleshoot issues with your Barryvox®



Learn about signal interference and how it can affect your device

Using the Barryvox® in a Rescue



Learn about automatic safety features, that keep you safe in case of secondary avalanches

SOS

What to do in case of an avalanche. How to organise your emergency response



Overview of search phases, from signal aquisition to pinpointing



Using the Barryvox® in a rescue. Learn about the specific interfaces and modes for the different search phases

Advanced Barryvox® Features



Discover the Advanced settings on the Barryvox®, which unlock pro-level test and search functionality

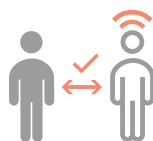

How to verify key transmission metrics with the Pro-check



How to use the alternative (analog tone) search mode and when it is applicable



Learn about when and how to use advanced search tactics

1	THE BARRYVOX® DEVICE	9
1.1	DEVICE DIAGRAM – BUTTON MAP	9
1.2	POWERING ON, WEARING AND ATTACHING THE BARRYVOX®	10
1.2.1	Attaching the safety leash and inserting into carrying System	10
1.2.2	Inserting the batteries	10
	Batteries	10
1.2.3	Powering on and setting up the device	11
	Main Switch OFF / SEND / SEARCH	11
1.2.4	The interface	11
1.2.5	Settings	11
	A UI Language	12
	B Owner	12
	C Voice Guidance	12
	D Advanced Settings	12
	E Group Check	12
	F Bluetooth	12
	G Factory Settings	12
1.2.6	Voice guidance	13
1.3	THE BARRYVOX® APP	14
1.4	SERVICE AND MAINTENANCE	14
1.4.1	Periodic check by an Official Mammut Service Center	14
1.4.2	Pre/post season	14
	Inspection	14
1.4.3	Battery handling	15
	A Battery Test and Battery Level Indicator	15
	B Change between Alkaline and Lithium Batteries	15
	C Battery Contacts	15
1.4.4	Troubleshooting	17
1.4.5	Warranty information	19
2	USING THE BARRYVOX® ON TOUR	20
2.1	HOW A TRANSCEIVER WORKS	20
2.2	WEARING THE TRANSCEIVER	21
2.3	BARRYVOX® SELF-TEST	21
2.4	GROUP CHECK	21
2.4.1	Regular Group Check	21
2.4.2	Warning Messages	22
2.4.3	SEND Confirmation	22
2.4.4	Double Group Check	23
2.5	ELECTROMAGNETIC INTERFERENCE (EMI)	24
2.5.1	Sources of Interference	24
2.5.2	SEND - Transmit Mode Guidelines:	24
2.5.3	SEARCH – Receive Mode Guidelines:	24

3	USING THE BARRYVOX® IN A RESCUE	25
3.1	AUTO REVERT TO SEND AND RESCUE SEND	25
3.1.1	Auto Revert to SEND	25
3.1.2	Rescue-SEND	25
3.2	EMERGENCY PLAN	25
3.2.1	Companion Rescue	25
3.2.2	Personal Rescue Equipment	25
3.2.3	If an Avalanche Occurs	26
3.3	OVERVIEW SEARCH PHASES	27
3.4	SEARCH WITH A BARRYVOX®	27
3.4.1	Signal Search	27
	Signal Search Strategies	27
	Reduced Search Strip Width	27
3.4.2	Coarse Search	28
	In Complex Situations Slow Down the Search	28
3.4.3	Fine Search	28
3.4.4	Pinpointing / Probing	30
3.4.5	Shovel	31
3.4.6	Multiple Burials	31
	Search for Multiple Buried Subjects Using the Standard Search Mode	31
	List of Buried Subjects	32
	Procedure for Multiple Burials	32
4	ADVANCED BARRYVOX® FEATURES	33
4.1	ADVANCED SETTINGS	33
4.1.1	Pro Search	33
4.1.2	Audio Guidance (Analog Tone)	33
4.1.3	Fine Search Guidance	33
4.1.4	Pro Check	33
4.1.5	Auto-Revert SEARCH to SEND	33
4.1.6	Auto Revert to SEND timeout	34
4.1.7	Vital Data	34
4.2	USING ADVANCED FEATURES ON TOUR	34
4.2.1	Using Pro Check	34
	How to Interpret the Parameters Measured by the Pro Check	35
	A Frequency deviation:	35
	B Period duration:	35
	C Pulse duration:	36
4.3	USING ADVANCED FEATURES IN A RESCUE	36
4.3.1	Analog Search Tone	36
4.3.2	Electromagnetic Interference and Analog Tone	36
4.3.3	Alternative search mode	36
	Multiple Buried Subjects in Alternative Search Mode	37
	Automatic or Manual Amplifier Mode (Volume / Gain Level / Sensitivity)	37
4.3.4	Sound Check	38
	“Sound Check”	38
	Mental Map of the Burial Situation	38
4.3.5	Selecting in the List of Buried Subjects	38
	Situation 1: Two rescuers detect two buried subjects	38
	Situation 2: Two rescuers only detect one buried subject	38

4.3.6	Cross Visual Guidance	39
4.3.7	Deep Burials	39
4.3.8	Burial Data	39
4.3.9	Vital Data BT & Triage	39
	Triage	39
	Vital Data BT	39
	Vital Data Detection	39
	Limitations of Vital Data BT Detection	40
4.4	ADVANCED SEARCH STRATEGIES	40
4.4.1	Search Tactics with Multiple, Widely Scattered Burials	40
4.4.2	Search Tactics with Multiple Burials in Close Proximity	41
	Interpreting Sound Checks	41
	Micro search strips	42
	Micro box	43
	The 3-circle method	43
5	FLEET MANAGEMENT AND SERVICE INFRASTRUCTURE	44
5.1	MAINTENANCE SOFTWARE	44
	Use in combination with the Barryvox® Maintenance Software	44

1 THE BARRYVOX® DEVICE

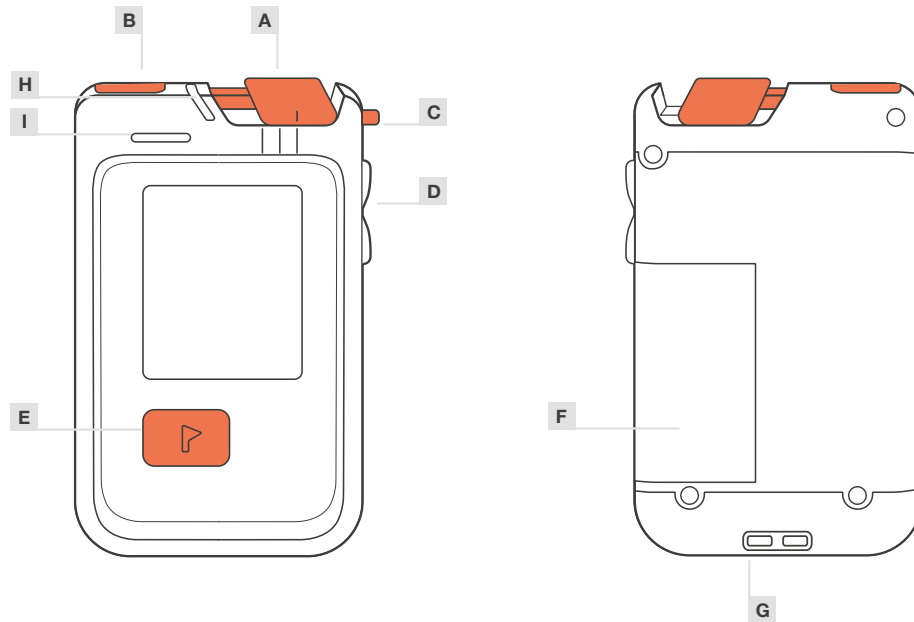

Illustration 1 Attach the safety leash to the eyelet on the device.

1.1 DEVICE DIAGRAM – BUTTON MAP

A Main switch OFF / SEND / SEARCH
OFF position: Device is switched off
SEND position: Device is in Send mode
SEARCH position: Device is in Search mode

B Unlock button
 Hold down to move main switch away from **SEND**
 The Unlock button is not required to set to **SEND**

C SEARCH-to-SEND switching aid
 Switch from **SEARCH** to **SEND**

D Side buttons
 Browse in buried subject list or device settings

E Mark button
 Confirm selection
 In **SEARCH**: Mark localized buried person

F Battery compartment

G Eyelet for safety leash

H SEND indicator light
 Flashing every second: Transmission signal OK
 No flashing: Transmission signal impaired
 (observe warning on display) In rescue **SEND**,
 double flashing every 3s

I Loudspeaker

1.2 POWERING ON, WEARING AND ATTACHING THE BARRYVOX®

1.2.1 Attaching the safety leash and inserting into carrying System

1. Pull the black strap of the carrying system over your head and left arm.
2. Place the gray elastic band around your waist and close the quick-release fastener. Adjust the strap lengths so that the carrying system is close to your body and fits securely.
3. Insert the Barryvox® into the carrying system with the display facing your body and close the quick-release fastener around the Barryvox®.
4. Attach the carabiner of the safety leash to the carrying system.

Warning



Wear the Barryvox® in the carrying system (recommended) over the base layer of clothing and cover it with at least one clothing layer.



Carry the Barryvox® without the carrying system in a zippered front trouser or bib pocket. Attach the safety leash to your trousers or a belt.



Always point the Barryvox® display towards your body.

1.2.2 Inserting the batteries

Open the battery compartment, insert the supplied alkaline batteries and close the flap by snapping it into place.

Batteries

Only use alkaline (LR03/AAA) or lithium (LR92/AAA) batteries. Always insert 2 new batteries of the same type. In case these batteries need to be removed, the same 2 batteries or 2 new batteries must be reinserted. Rechargeable batteries can cause malfunctioning of the transceiver and must never be used. Always replace both batteries at the same time. Make sure the lid is properly closed and that the device and the batteries stay dry.

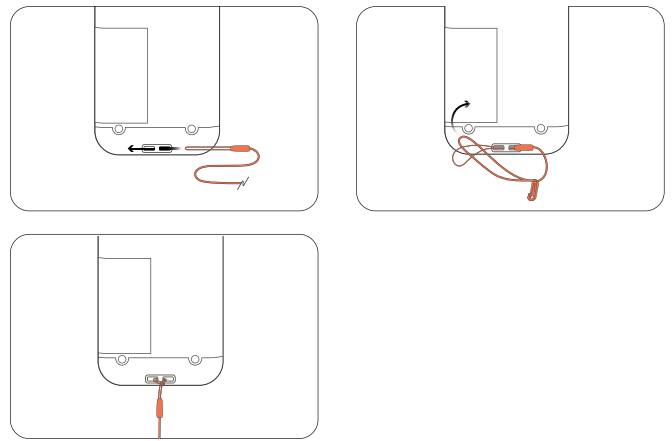

Illustration 2 Attach the safety leash to the eyelet on the device.

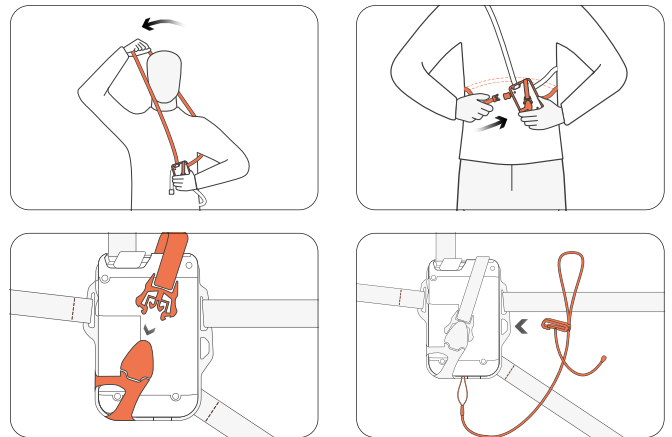

Illustration 3 Putting on the carrying system

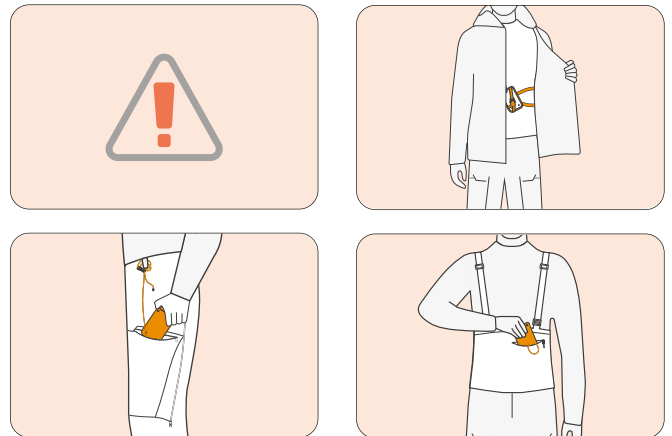

Illustration 4 Wear the transceiver with the screen facing inwards

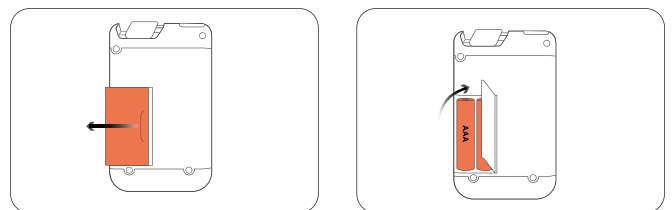

Illustration 5 Opening the battery compartment

1.2.3 Powering on and setting up the device

Main Switch OFF / SEND / SEARCH

The main switch is located on the top of the device. In the left position **OFF**, the device is turned off, in the center position **SEND** the device is in **SEND** mode and in the right position **SEARCH**, the device is in **SEARCH** mode. For safety reasons, it is required to press the hinged unlock button to leave the **SEND** mode. To return from **SEARCH** to **SEND**, simply push the main switch sideways.

Always make sure that the switch locks into position mechanically to avoid an undesired change of mode.

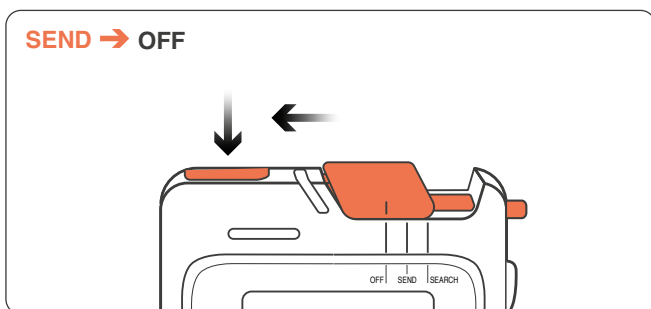
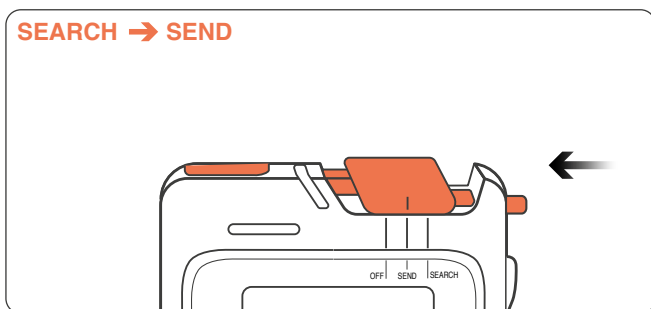
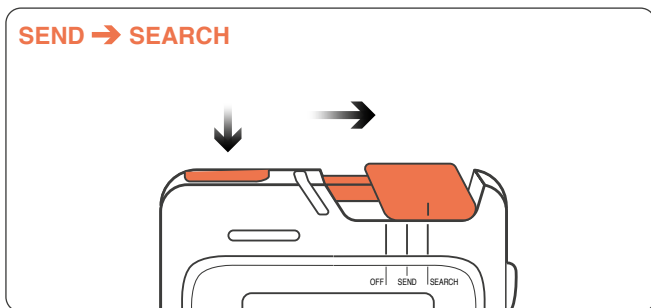
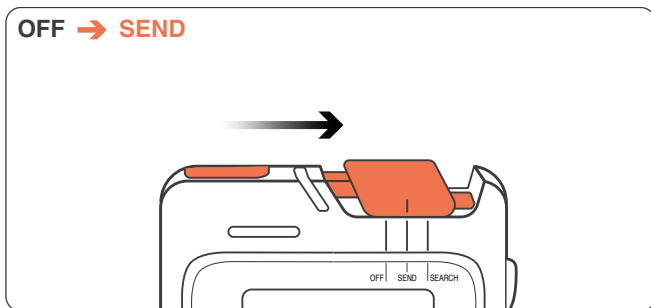
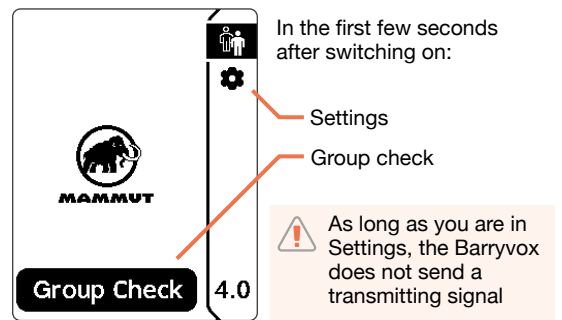

Illustration 6 Button positions

1.2.4 The interface

SEND



SEND

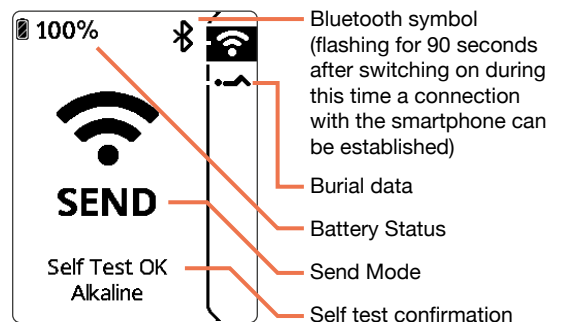

SEND

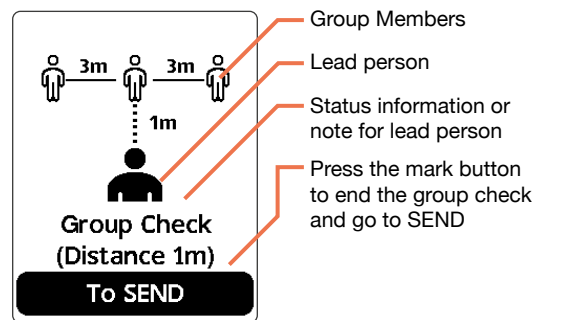

SEARCH

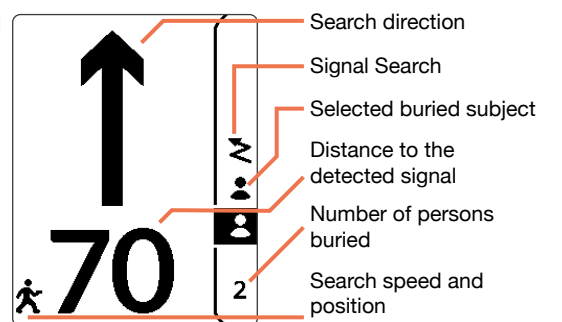

Illustration 7 The interface

1.2.5 Settings

Access to the settings menu is only possible during the initial start-up sequence or via the Barryvox® app. For safety reasons, there is no access to the settings once the device is in group check, **SEND** or **SEARCH** mode.

The main purpose of the settings is to allow users to adapt the user interface and available functions of the device to best fit their individual requirements and capabilities. By default the transceiver is set up for ease of use by novice users. "Pro-users" can enable advanced features, described in [Advanced Barryvox® Features \(p.33\)](#)

A UI Language

This setting allows you to select the language of your transceiver's user interface.

When turning the device on for the first time (switching to **SEND**), the user language must be selected. Use the side buttons to scroll up or down in the list and confirm your selection by pressing the button on the front. To change the language of the Voice Guidance, use the [The Barryvox® App \(p.14\)](#)

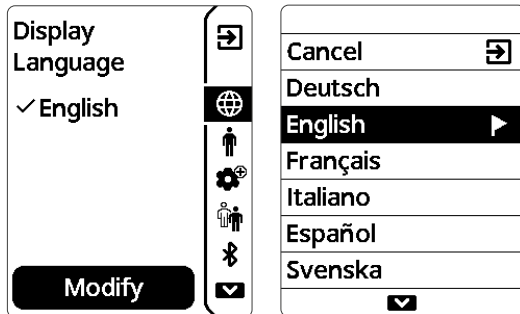

Screenshot 1 Language Settings

B Owner

The Barryvox®S2 allows you to enter your name, address, and other information, such as your emergency phone number or e-mail address. This information is displayed every time the transceiver is turned on. The information can also be viewed in the settings menu of the Barryvox®. To enter or edit owner information, use [The Barryvox® App \(p.14\)](#).

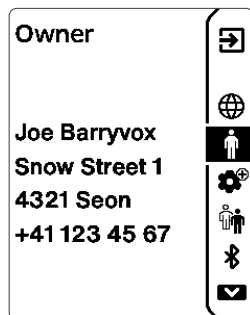

Screenshot 2 Owner Settings

C Voice Guidance

Delivers complementary voice instructions and support during all search phases.

For legal reasons the voice guidance feature is only available in certain regions. Before activating the feature, we need to establish if it is available in your region. To do this you must connect the transceiver to the Barryvox® App and have an active internet connection and GPS location. In the [“Devices tab \(p.14\)”](#) tab select “Voice Guidance” then “Check Availability”. The App will run the check automatically and allow you to activate the feature if it is available.

The voice instructions and warnings are explained in detail in the [Voice guidance \(p.13\)](#) section.

D Advanced Settings

For professional users and for complex search scenarios advanced settings available. These include features to activate analog mode, mitigate instances of signal interference or advanced device checks. The Advanced Features are explained in [Advanced Barryvox® Features \(p.33\)](#).

E Group Check

The group check setting allows to define the test distance during the group check. Choose «Snowmobile» (5m) for motorized applications and «Ski, Board, on Foot» (1m) for all other cases

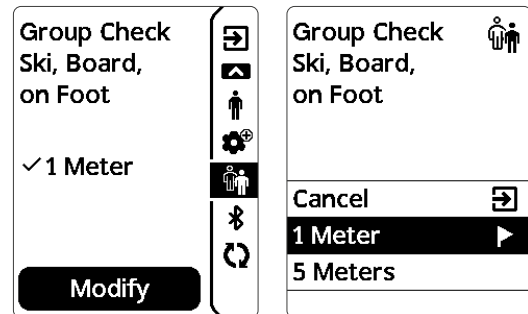

Screenshot 3 Group Check Settings

F Bluetooth

Barryvox®S2 allows you to manually switch off Bluetooth functionality. Bluetooth is used for Barryvox® App connectivity, Barryvox® Training Park or communication between Barryvox® devices in a rescue scenario.

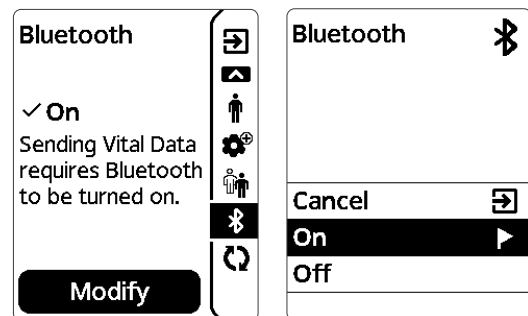

Screenshot 4 Bluetooth Settings

G Factory Settings

This allows you to restore all default factory settings. All modified settings, except the owner information are lost.

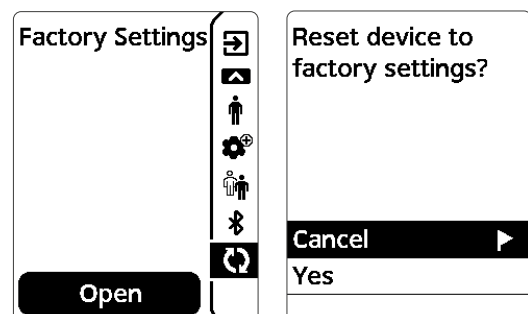

Screenshot 5 Factory Settings

1.2.6 Voice guidance

During a search spoken audio cues will help you during all phases of the search. It will provide instruction and remind-

ers on search speed, direction and best practices to speed up the rescue. The table below describes the audio instructions and warnings you may receive during the search.

Phase	Voice Alert	Description
Signal search	Keep visual focus on the snow surface and begin to search.	During Signal search it's crucial to keep visual focus on the snow to spot partially buried subjects, inflated airbags, skis, gloves and so on.
	Move fast.	During Signal search it's important to move fast to pick up a signal and not waste any time.
Interference	Remove all electronics.	All avalanche transceivers are very sensitive to electronic devices nearby. If the Barryvox® detects interference from an electronic device during the signal search it will notify you
Coarse search	Move slow.	When entering the coarse search (<10m) phase it's important to move slower to increase search precision.
	Turn around.	If you are moving in the wrong direction the Barryvox® tells you to turn around.
Fine search	Hold the device at knee height.	When entering fine search phase (<3m) it's important to move very slowly and hold the transceiver close to the snow surface to increase search precision.
	Follow the arrow.	When using Intelligent Fine Search Guidance the Barryvox® tells you to keep following the arrow. It's crucial to follow the instructions on the display precisely (arrows).
	Search for the smallest value.	When using Classic Cross Search, you will have to perform a cross search and find the smallest value.
	Begin probing.	When using Intelligent Fine Search Guidance the Barryvox® tells you when to start probing (Probing indication)
Group check	More than one transmitter.	If there is more than one device transmitting in close proximity during the group check, you need to restart your group check and increase the distance between each device.
	Too close.	The Barryvox® tests for correct send function as well as signal strength, which requires 1m of distance between Barryvox® and the transmitter (sender).
Warnings	Warning, battery low.	Warning when the battery is below 40% for alkaline and below 30% for lithium batteries.
	Slow down the search.	When there are issues in detecting the current signal you need to slow down your search speed until the distance reading on the display stops flashing.

1.3 THE BARRYVOX® APP

The Barryvox® app connects to the Barryvox® S2 or 2 and allows users to view and change device settings, update firmware and view transceiver information. Additionally users can access the comprehensive Barryvox® Training Park feature. The app is available for iOS and Android devices. When the Barryvox® successfully connects to the Smartphone App you will hear a double beep sound confirming the connection.

Devices tab

This section of the app allows you to connect your transceiver(s) via Bluetooth. It will list all transceivers that have been connected to the app and will allow fine control over the settings. Information such as firmware version, firmware update, owner information, serial number and warranty information can all be found here.

Training tab

The Barryvox® Training Park allows the user to set up a variety of training scenarios in the field to hone their skills and systematically work through progressively more complex scenarios. Throughout the training the app stays connected to all Barryvox® in the training scenario. The Bluetooth connection allows you to check the status of each Barryvox® and automatically record probe hits and log the timing.

Settings tab

This section of the app allows you to link to your Mammut account and adjust some general settings. Additionally, you will find the data protection policy and the terms and conditions.

When the Barryvox® is connected to your smartphone you will see the following screen on your Barryvox®.

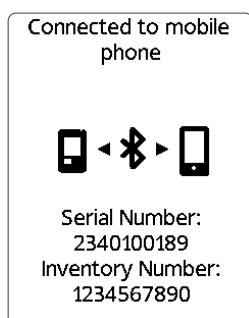

Screenshot 6

App Connection

1.4 SERVICE AND MAINTENANCE

1.4.1 Periodic check by an Official Mammut Service Center

To check the proper function of the device it is highly recommended that the device is sent to an official Mammut Service Center (service charge will apply) every 3 years or

after 3000 hours of operation. The functional test is much more comprehensive and precise than the self-test and group check. As part of this service the electronics and the mechanical components such as the case, the main switch and the lateral key, the battery contacts, the battery compartment and cover as well as the wrist strap will be checked. In case the check shows abnormal wear and tear due to incorrect or long, very intense use, the Mammut Service Center may recommend that you replace the device.

We recommend that you have your device checked during the summer months so that your Barryvox® is tested and ready to use at the start of the winter season. When shutting down the transceiver the date for the next periodic check will be shown on the display.

In the maintenance tab, accessed by pushing the button when shutting down the transceiver, the date of the last check as well as the software (SW) and hardware (HW) version is displayed.

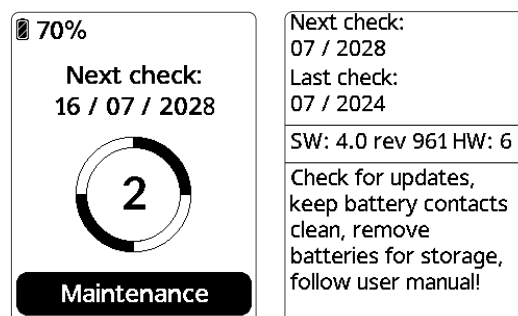

Screenshot 7

Warranty date on shut down (L),
maintenance screen on shutdown (R)

1.4.2 Pre/post season

Inspection

Before and after every tour:

- The housing must not be damaged, and the display must be easy to read.
- All switches and buttons must function properly.
- The battery compartment must be dry
- The battery contacts must be free of corrosion and maintain sufficient spring pressure (see “battery handling”).
- Prior to every tour, the battery status of your Barryvox® should be at least 40% with alkaline batteries and at least 30% with lithium batteries.

Prior to the season:

- Check If you need to replace your batteries, use only new alkaline (LR03/AAA) or lithium (L92/AAA) batteries of the same type, same brand, same production date and same packaging. Never use rechargeable batteries. When replacing the batteries with new ones, always replace them all at the same time.
- Check if firmware updates are available using the Barryvox® App.

After the season:

- Remove the batteries from the device to prevent them from leaking during prolonged storage. Tip: Store them together with a rubber band attached, to make sure you use exactly the same batteries at the start of the next season.
- Have your device officially checked regularly. The next maintenance date can be seen when you switch off your Barryvox®.
- Store in a dry placed, protected from direct sunlight.

1.4.3 Battery handling**A Battery Test and Battery Level Indicator**

The following table gives you average values for the battery levels. The remaining battery level can only be displayed correctly if batteries are used according to the section "Inserting Batteries". Low temperatures, age, and brand can have a negative impact on battery life and the accuracy of the battery level indication.

Recommendation: As the risk of a battery failure increases towards end of the battery life, we recommend replacing the batteries 10% before reaching the emergency reserve. Please replace alkaline batteries at 40% and lithium batteries at 30%.

100%**Normative requirement (=minimum requirement):**

min 200hrs SEND at 10°C followed by
1hr SEARCH at -10°C

Typical values for the Barryvox® S2 with alkaline batteries:

450hrs SEND at 10°C (measured with PULS Power).

Typical values for the Barryvox® S2 with lithium batteries:

550hrs SEND at 10°C (measured with Energizer ULTIMATE and ADVANCED)

Less than 30% (alkaline) / 20% (lithium)

The batteries must be replaced as soon as possible!

Emergency reserve at 30% (Al) / 20%(Li):

Max. 20hrs in SEND mode at 10°C and max 1hr in SEARCH mode at -10°C left

Battery capacity unknown

The battery capacity cannot be reliably determined.

The batteries must be replaced as soon as possible!
The transceiver sounds a warning if the battery level is running on emergency reserve or unknown at startup.

B Change between Alkaline and Lithium Batteries

As soon as one battery is removed and reinserted or replaced, the device tries to recognize the battery type (alkaline or lithium).

Be aware of the following important details when answering the questions:**2 new**

Only confirm this questions if you really inserted 2 brand new lithium batteries, which have never been used before in any other device.

The same

Only confirm this question, if you have removed one or multiple batteries and immediately reinsert the same batteries. Never insert used batteries (i.e. batteries you have removed and stored together over the summer).

Unknown

You must take this choice when you have mixed alkaline and lithium or inserted lithium batteries which you have used before, or in the meantime, in other devices.

If you mix alkaline and lithium batteries or try to use lithium batteries which have already been used in other devices, it is impossible to determine the battery capacity. In this case, the alert message "Battery capacity unknown!" will be shown.

C Battery Contacts

A Reliable connection between the battery contact in the battery compartment and the individual battery cell contact pole is crucial for the safety, performance, and reliability of the device. Sufficient spring pressure and a clean contact surface are important to maintain this connection. Testing of battery contacts is part of the visual and mechanical checks as described in [Pre/post season \(p.14\)](#).

Testing Battery Contacts for Mechanical Integrity and Spring Pressure

Do not bend the battery contacts. If there is a bent/damaged contact or the spring force is low, the unit must be sent to an official Mammot Service Center to replace the battery contacts (see [Fleet Management and Service Infrastructure \(p.44\)](#)).

To verify if the spring force of the battery contacts is within tolerance, visually check the distance between the back wall of the battery contact and the lower end of the spring. The spring must not touch the backwall, otherwise there is no more flex. If the spring has collapsed (permanent defor-

mation), which may happen when the device is exposed to a major fall, the spring force is too low and the battery contact needs to be replaced. If the distance between the lower end of the spring and the back wall is much greater than normal or the spring is mechanically deformed, the battery contact has been mistreated and also needs to be replaced.

Cleanliness and Corrosion

The acid of leaking batteries is very destructive to battery contacts and can easily cause corrosion. Depending on the amount acid and the level of corrosion, it will leave matte white, blue or green colored marks on the shiny battery contacts (see [Illustration 8](#)). Battery contacts must be clean and free of any corrosion or leakage at all times. If a battery contact is corroded, the unit must be sent to an official Mammut Service Center for replacement of the battery contacts (see [Fleet Management and Service Infrastructure \(p.44\)](#)). Corroded contacts lead to a high probability of eventual power supply problems.

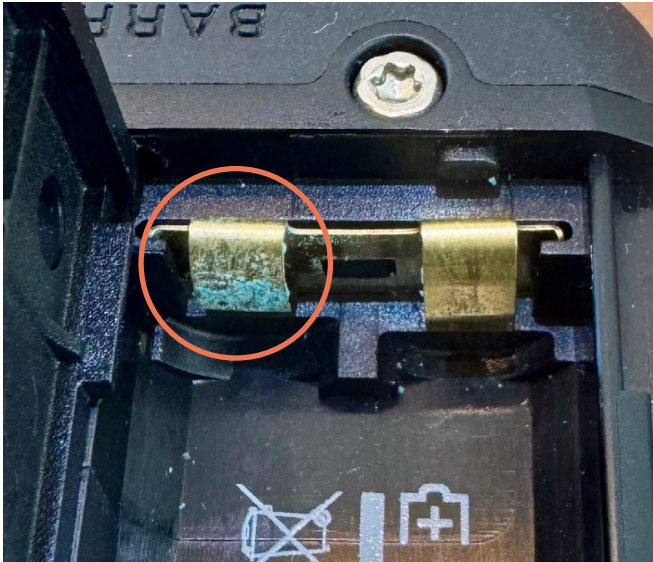

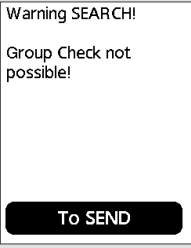
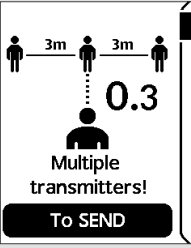
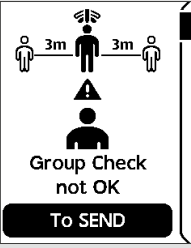
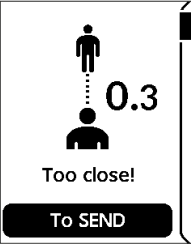

Illustration 8 Battery contact with clear signs of leaked batteries which require the contact to be replaced.

1.4.4 Troubleshooting

The table below describes the error messages you may receive on your Barryvox®. For battery errors check and replace the batteries. For other errors shut down the device

and turn it back on to retry. If the errors persist have the device checked by the manufacturer.

Mode	Alert	Description
Selftest		<p>Warning SEARCH!</p> <p>Increase distance to electronic devices and metal parts, then restart the device.</p>
		<p>Warning Sensor!</p> <p>Restart device!</p>
Group Check		<p>Self-test failure: Group Check not possible because test of all 3 Antennas in search / receiving mode failed.</p>
		<p>More than one transmitter detected within close area during Group Check.</p>
		<p>The measured send signal in Group Check is not ok. Do not use this device on Tour.</p>
		<p>Sendin/transmitting device is too close to the receiving device during Group Check.</p>

Mode	Alert	Description
Group Check	Hold both devices vertically!	In Pro Check mode, when the measured pulse is below 70ms, hold the device vertically.
Tx	Warning SEND!	Send signal is too weak. This is caused by passive interference or broken antenna. Test is performed continuously.
Rx	Warning! Switch off ALL electronic devices!	Interference detected in Search mode (strong disturbance) -> reduced strip width of 20m
Battery (all modes)	Battery low!	Warning when battery level is below 30% for alkaline and below 20% for lithium batteries.
	Replace batteries as soon as possible!	Warning when battery level is below 1%
	Battery\ncapacity\nunknown!	Warning when there is issues detecting the correct battery type. Insert new alkaline or lithium batteries.

1.4.5 Warranty information

There is a 2-year warranty on the Barryvox® transceiver (excluding the batteries, the carrying system and the leash) from the date of purchase shown on the purchase receipt. If you register your device through the Barryvox® App, the existing warranty duration, starting from the date of purchase shown on the purchase receipt, will be prolonged by an additional 3 years to a total of 5 years of warranty. In case of a warranty claim, all parts that can be shown to have material or production defects will be replaced free of charge. Damage that can be traced to incorrect handling or normal wear and tear is excluded.

The warranty is voided if the buyer or any non-authorized third party opens or modifies the device. This is also the

case for devices that have been used with spare parts or accessories which are not original and are not recommended by the manufacturer.

A fee will be charged for the diagnostic test of a transceiver not needing any repair. Warranty repairs do not extend the duration of the warranty. There is a six-month warranty on replaced spare parts. Warranty repairs will only be conducted if the device is sent in along with the receipt.

The owner will be charged for the shipping. No other warranty shall exist. Any liability for any kind of loss or damage including but not limited to any direct, indirect, or consequential damage is explicitly excluded.

2 USING THE BARRYVOX® ON TOUR

2.1 HOW A TRANSCEIVER WORKS

Avalanche transceivers are subject to the EN300718 standard. A uniform standard specification ensures that all devices that meet the EN 300718 standard, and thus transmit on the 457 kHz frequency, are compatible with each other.

Avalanche transceivers have two operating modes: SEND and SEARCH. In practice, devices are normally carried in SEND mode and switched to SEARCH mode only in the event of an avalanche search. An avalanche transceiver's two operating modes can never be active at the same time.

The avalanche transceiver's 457 kHz transmitter has a spatial, kidney-shaped, field line pattern wave propagation characteristic. The searching transceiver guides the rescuer

to the buried subject following the flux lines and not in a straight line. Barryvox® devices* are 3-antenna devices. All 3 antenna are used for searching, but just one antenna is only ever used for transmitting. The carrier frequency or the primary signal works in the 457 kHz frequency range and is transmitted in a field line pattern. According to the specifications of the standard, the transmitted signal can vary from the base signal by +/- 80 Hz. For extra security, Barryvox® devices* receive signals with a deviation of up to +/- 180Hz.

Elementary understanding of transceiver search

The 457kHz transmitter of the transceiver has a kidney shaped transmit distribution, which is visualized with flux lines in the illustration below. The searching transceiver's arrow leads the rescuer along the field lines and therefore usually in a curved line to the buried subject.

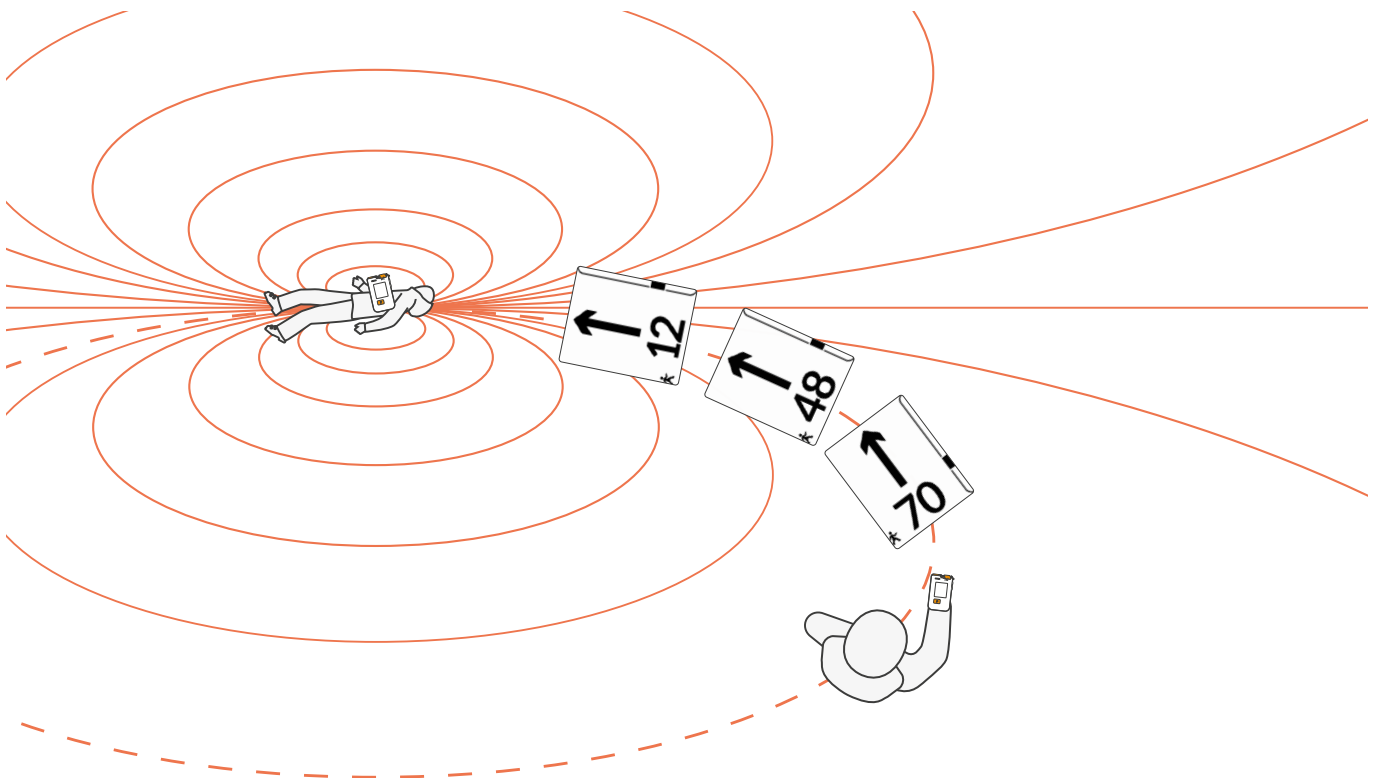

Illustration 9 Search along the flux line

2.2 WEARING THE TRANSCIVER

Wear the transceiver as described in [Powering on, wearing and attaching the Barryvox® \(p.10\)](#)

2.3 BARRYVOX® SELF-TEST

While starting up, the device performs an automatic self-test to ensure it is transmitting and receiving signals correctly. This includes a comprehensive check of all sensors, control system, and storage. The result of the self-test will be shown on the display the first time the device enters SEND mode. Additionally, the positive self-test will be confirmed by the *Signature Barryvox® Triple Beep Sound*.



Screenshot 12 Self test positive

During operation, the device continuously monitors the SEND function and the batteries. With each outgoing pulse, the send signal is tested. The positive test result is indicated by each red blink of the control LED. Additionally, the

battery is continuously checked to ensure it has sufficient capacity. If the battery level drops below 30%, a warning is issued.

2.4 GROUP CHECK

2.4.1 Regular Group Check

Before setting off on tour, the avalanche transceivers of all group members must be checked by the group leader using the group check function. The Barryvox® tests the correct send function and strength.

1. All group members switch their avalanche transceivers to **SEND**.
2. The lead person sets their Barryvox® from **OFF** to **SEND** and presses the Mark button in the first 5 seconds to start the group check.
3. Group members stand at least 3 m away from each other so as not to interfere with each other's signal.
4. The lead person checks the signal of all avalanche transceivers one after the other at a distance of 1 m, **but no less than 0.5 m**. If the distance indicated on the screen and actual distance do not match, this indicates reduced send signal power due to interference or a broken antenna.

For a successful group check, the lead person's Barryvox® must emit at least one double beep and display a "Group Check OK" confirmation for every avalanche transceiver that is checked.

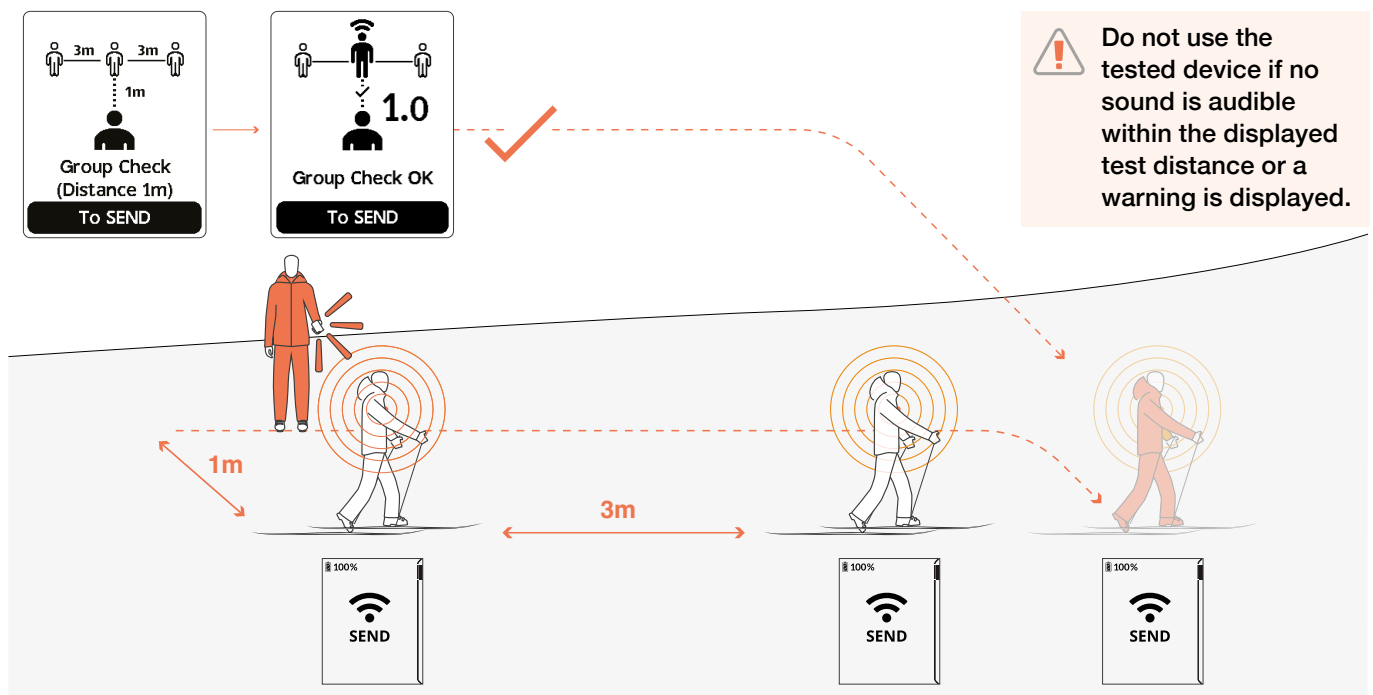

Illustration 10 Transceiver group check

In case of irregularities, check:

- Is the avalanche transceiver set to **SEND**?
- Are the batteries OK?
- Distance rule observed?

Warning still there? Have your device checked by the manufacturer.

- The lead person closes the group check with the Mark button and thus switches to **SEND**. A three-beep sequence confirms this.

2.4.2 Warning Messages

During a group check the Barryvox® will warn if the transceivers are too close or if there are multiple transmitters in proximity.

Too close!

During group check the Barryvox® requires an ideal distance of 1m between receiver and transmitter. If you are too close it cannot check for the correct signal strength of the transmitter. Increase your distance between receiver and transmitter to 1m.

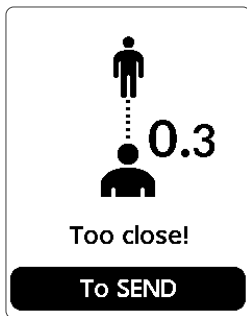

Screenshot 13 Groupcheck too close

Multiple transmitters!

This warning will come up when there is more than one transmitter around the receiver in a radius of 3 meters for ski, snowboard, foot or 5m for snowmobiles, respectively. Increase the distance between the group members.

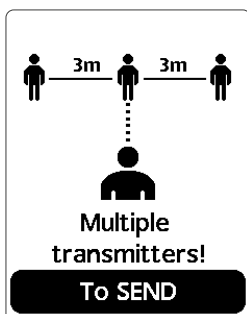

Screenshot 14 Multiple transmitters

If your Barryvox® detects that the transmit frequency of the tested device is out of tolerance, a warning message “Group Check not OK” will be shown. Such devices must be checked by an official service center of the manufacturer.

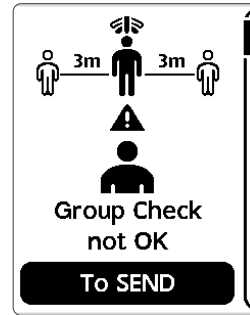

Screenshot 15 Group Check not OK

2.4.3 SEND Confirmation

In case a regular group check is impossible due to limited space, it is possible to perform a basic verification if the transceivers of all participants are turned on. The leader holds his transceiver in group check as close as possible to the transceiver of each participant.

By doing so, the distance indication must decrease to the point where it is impossible to mix-up the result due to proximity of other participants. As the test distance is too short for a regular group check, there is no affirmative confirmation (double beep). If the indicated distance to the transceiver being checked does not decrease to a value that rules out other participants' transceivers, a regular group check must be performed. In any case it is recommended that a regular group check is performed, when possible, to ensure the proper functioning of all participant's transceivers.

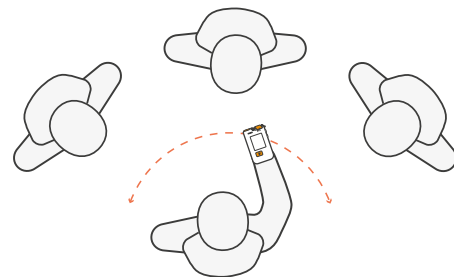
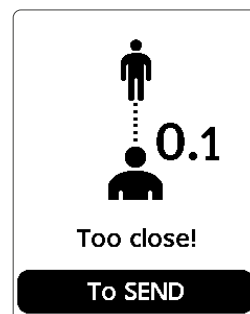

Illustration 11 Send Confirmation



Screenshot 16 Send Confirmation

2.4.4 Double Group Check

We recommend performing a double group check once a week and in general whenever a new group gets together. The double group check individually tests the **SEND** and **SEARCH** function of all devices. Members of the party activate the group check on their transceivers or set them to **SEARCH**. The leader switches their transceiver to **SEND** mode and ensures that all group members receive his signal with a correct distance reading on their display. Subsequently, the group members switch their transceivers to **SEND**, and the leader activates the group check or sets the transceiver **SEARCH**. The **SEND** mode of all transceivers is checked as described above for the regular group check, and ultimately the leader switches his or her transceiver to **SEND**.

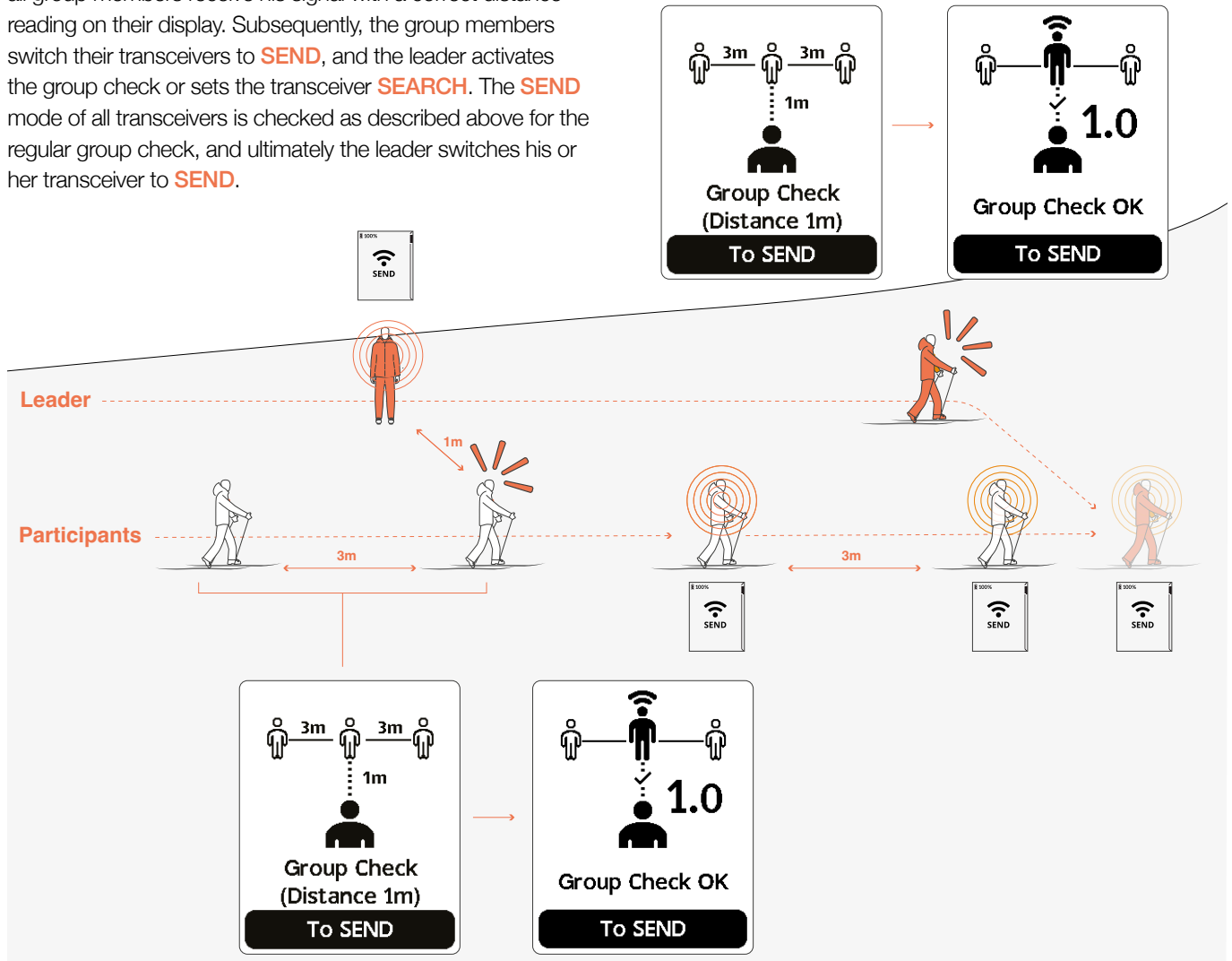

Illustration 12 Extended Group Check

2.5 ELECTROMAGNETIC INTERFERENCE (EMI)

The signal from an avalanche transceiver can be negatively affected by metallic objects or electronic devices. These include smartphones, radios, headlamps, sports watches, action cameras, heated gloves, pacemakers, and magnetic buttons. We recommend that electronic devices that are not required are switched off. Possible consequences of interference are misleading direction and distance indication (false positives) and range reduction.

The Barryvox® continuously conducts a self-test from the moment it is switched on, checking for possible interference. If a warning is displayed follow the instructions on your Barryvox® and do not set off on a tour. See [Trouble-shooting \(p.17\)](#) for more information on warning messages

2.5.1 Sources of Interference

Passive Interference (affecting SEND and SEARCH)

Metal parts, electronic devices with metal cases, foils, wire mesh, and magnets can cause interference. Keep these items at least 20 cm away from your transceiver.

Active Interference (affecting SEARCH)

Any electrically powered device can interfere with your search. Follow the guidelines in the SEARCH section to avoid reduced range and “false positives”.

2.5.2 SEND - Transmit Mode Guidelines:

When using the SEND mode, keep your Barryvox® at least **20cm** away from sources of interference (as described above) If you can maintain this minimum distance all your devices may remain in use.

Keep your phone in a pocket on the opposite side of your body from the transceiver. Avoid carrying a phone in your jacket pocket or an action camera at chest level while wearing your avalanche transceiver in its holder. This prevents the devices from being too close to each other in case of an avalanche, which could disrupt the transmission signal. Discuss this topic with your group to ensure everyone is aware of the potential interference sources.

2.5.3 SEARCH – Receive Mode Guidelines:

When in SEARCH mode (searching rescuer), only keep absolutely essential electronic devices switched on and keep them at least **50 cm** away from your Barryvox®. Other people at least 10 meters away can keep their devices on. Similarly maintain a distance of more than 10 meters from any turned-on mobile phone, radio, or satellite communication device or snowmobile with a running engine.

In general, for a search, remove heated gloves and completely turn off communication and other electronic devices (no airplane mode). Turn off heated socks and boots. If you are using a watch with an electronic screen or a bracelet with sensors for activity or heartrate monitoring, hold the transceiver in the opposite hand. Keep at least 50 cm away from essential devices like a headlamp during a night search. If interference can't be avoided by maintaining distance, reduce the search strip width to a maximum of 20 meters. Some electric airbag systems may cause interference, so if you're using one, consider searching without it. See [Electromagnetic Interference and Analog Tone \(p.36\)](#) for more advanced information and techniques on how to cope with interference.

3 USING THE BARRYVOX® IN A RESCUE

Although the avalanche transceiver is easy to use, its effective use requires proper training. We recommend that you practice transceiver searches regularly. As mentioned in [Electromagnetic Interference \(EMI\) \(p.24\)](#) it is highly recommended that all electronic devices which are not absolutely required are switched off! At the start of and during the rescue, ensure that the rescuer's transceivers are not transmitting. All non-searching participants on the search site should set their Barryvox® to **RESCUE-SEND** (see [Rescue-SEND \(p.25\)](#)).

3.1 AUTO REVERT TO SEND AND RESCUE SEND

3.1.1 Auto Revert to SEND

Auto Revert to **SEND** is a protective feature for searching rescuers in the event of burial by a secondary avalanche. If the transceiver doesn't detect any motion for a specified amount of time it automatically switches back to **SEND**. This is crucial in case a secondary avalanche buries rescuers or if a device is unintentionally left in, it increases the chance of being found in time. This feature is on by default, users can turn it on/off or change the timeout in [Advanced Settings \(p.33\)](#)

3.1.2 Rescue-SEND

Rescue-SEND is a protective feature for non-searching rescuers in the event of burial by a secondary avalanche. In this mode, the sending signal is temporarily stopped to avoid disrupting the search for buried subjects. In this mode if the transceiver doesn't detect any motion for a specified amount of time it automatically switches back to **SEND**. Non-searching participants (e.g. Liaising with mountain rescue) need to switch to this mode by switching to **SEARCH** then back to **SEND**, they will be prompted to switch on Rescue-**SEND** by pressing the mark button.

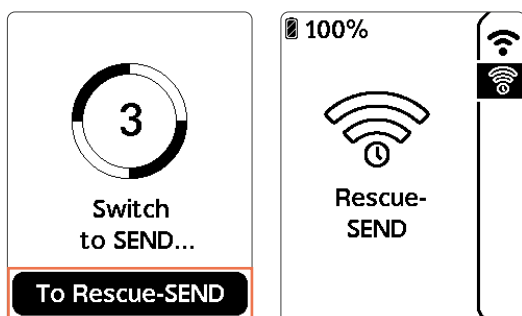

Screenshot 17

Rescue send

3.2 EMERGENCY PLAN

3.2.1 Companion Rescue

Companion rescue means that buried subjects are located and excavated by members of their party immediately after the avalanche. Avalanche rescue is a race against time! While most buried subjects can survive if rescued within the first 18 minutes, the chances of survival decrease rapidly afterwards. Companion rescue, therefore, provides the greatest chances of survival for a buried subject.

3.2.2 Personal Rescue Equipment

Carrying the proper personal safety equipment is critical for effective companion rescue and your own safety. A transceiver, a shovel, a probe and an avalanche airbag are the minimum pieces of equipment necessary to protect yourself and locate and excavate a buried subject quickly and efficiently. The use of an airbag system (flotation device) significantly reduces the risk of complete burial and therefore leads to considerably higher survival chances. Mammut offers a variety of suitable probe poles, shovels and avalanche airbags

The airbag can prevent a burial and serves as your primary safeguard, but you are still always required to carry a transceiver, shovel and probe. Carrying a radio or a mobile phone to call for help is highly recommended.

Keep your backpack on and all your equipment in it during a rescue! The assembled shovel and probe are a hindrance during signal and coarse search. Only remove your backpack to assemble probe and shovel once you have successfully concluded the fine search.

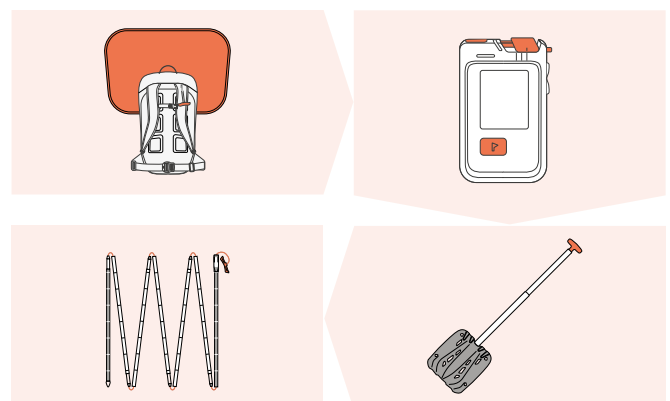

Illustration 13

Personal rescue equipment

3.2.3 If an Avalanche Occurs

As a Victim:

- Escape to the side
- Discard skis, snowboards, and poles as these have an anchoring effect
- Try to stay on top with swimming motions
- Close your mouth; place your hands in front of your face
- Keep airways clear during the avalanche

Separate instructions apply for the use of specialized safety equipment, such as the highly efficient avalanche airbag.

As a Witness/Rescuer:

- Keep eyes on victim, and direction of avalanche
- Turn transceivers to **SEARCH** mode or **RESCUE-SEND**
- Organise your search party (if others are available)
- Call mountain rescue

The above instructions provide only a very brief overview of the steps to be taken in a rescue. A more detailed look at the various scenarios, techniques, decisions involved when an avalanche occurs is out of the scope of this document. We strongly encourage further avalanche training where these aspects are covered in more detail.

The emergency plan shows the elementary steps for a successful companion rescue. Depending on the situation at hand, the procedure must be adapted.



Illustration 14 Emergency plan on the back of the device

3.3 OVERVIEW SEARCH PHASES

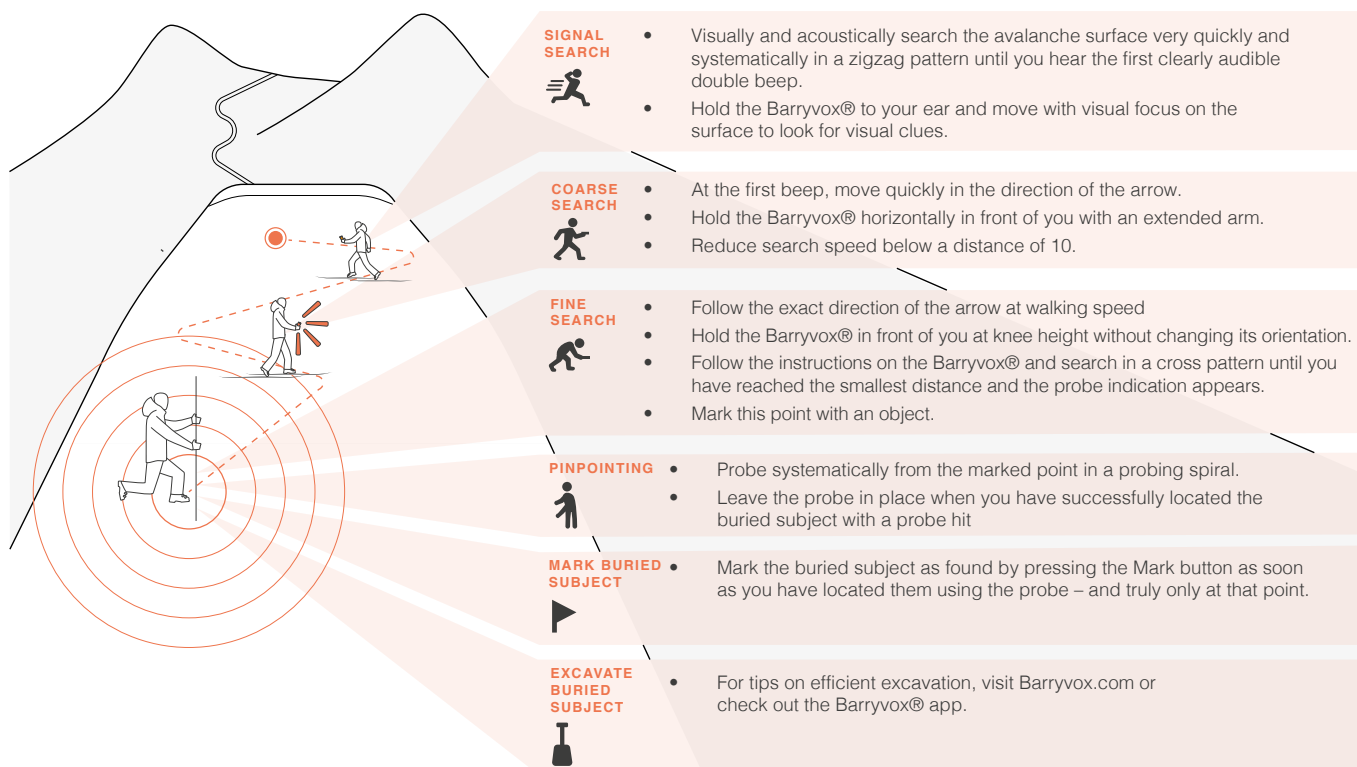
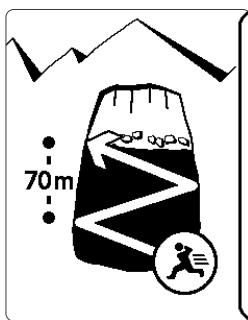

Illustration 15 Search Phases

3.4 SEARCH WITH A BARRYVOX®

3.4.1 Signal Search

Signal search is the phase of the rescue between turning your transceiver to **SEARCH** mode and detecting a signal from a buried subject. The avalanche surface is searched systematically in a zigzag pattern until you pick up a signal. The pickup of the first signal will be confirmed by the Barryvox® through a double beep sound. During the acoustic signal search, the rescuer has to visually focus on the surface of the debris to be able to see body parts or objects protruding the snow surface. However, objects are not necessarily attached to the victim, so confirm that they are the source of the signal before digging out the object.



Screenshot 18 Signal search

Signal Search Strategies

A Search strategy if the last seen point is known

The signal search starts downhill from the last seen point in the direction of the slide. Move quickly and systematically in a zigzag pattern with a search strip width of 70m.

B Search strategy if the last seen point is unknown

The signal search starts from the top of the slide. Move downhill quickly and systematically with a search strip width of 70m.

Reduced Search Strip Width

Electromagnetic Interference (EMI) from other electronics, devices transmitting outside the standard frequency, old transmitters with very long pulse durations or a high number of buried subjects are all factors leading to more complexity in a search. If the Barryvox® detects any of this, it reduces the signal search strip width to 20m. **Advanced Barryvox®-Features (p.33)** can help dealing with these complexities.

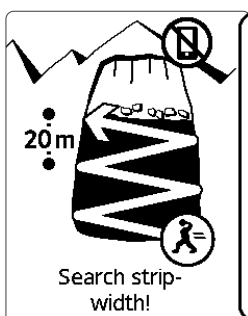

Screenshot 19 Reduced Search Strip Width

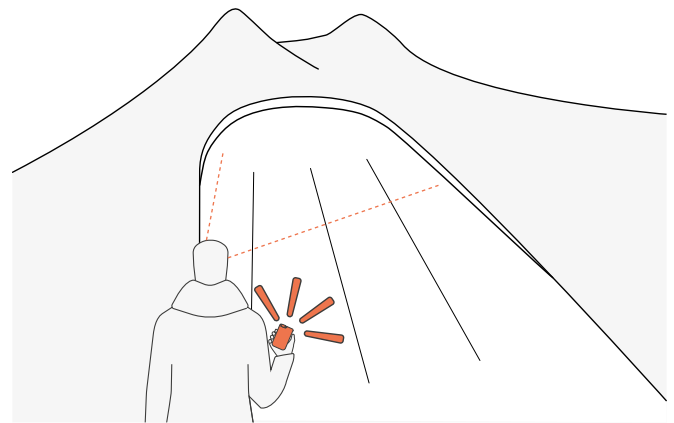

Illustration 16 Keep an eye on the snow surface for any signs of the buried subject

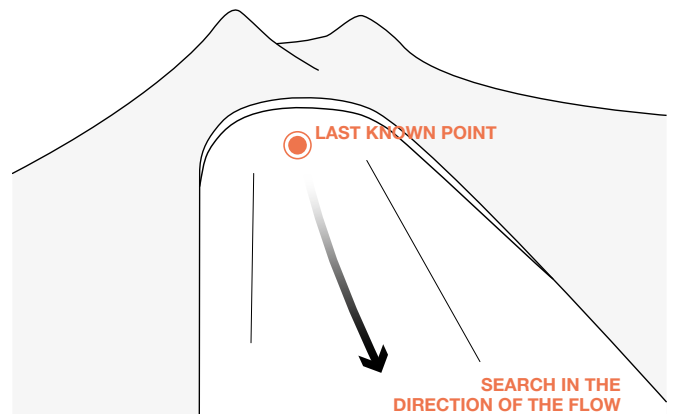

Illustration 17 Start at the last known point

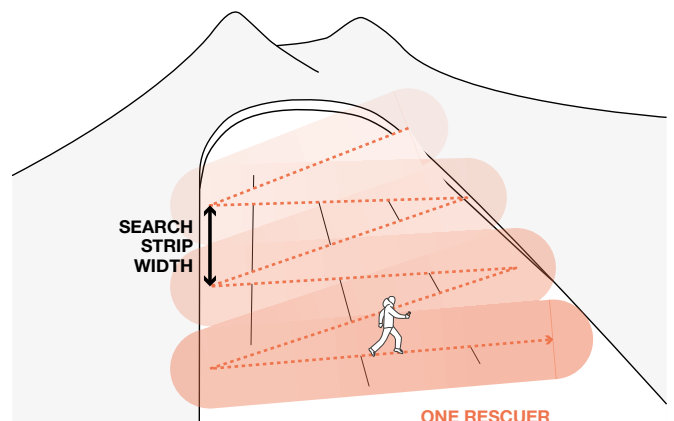

Illustration 18 Signal search pattern with one rescuer

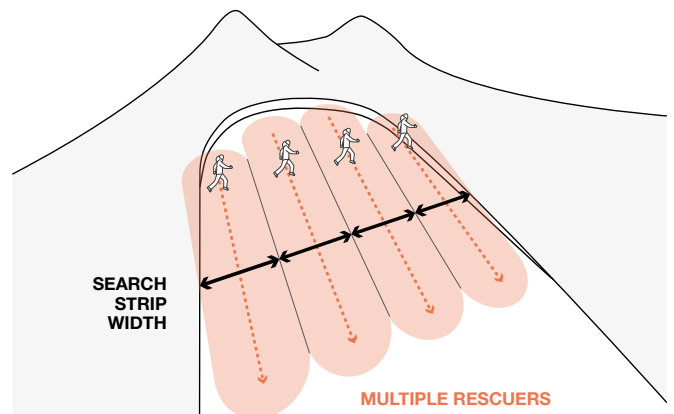
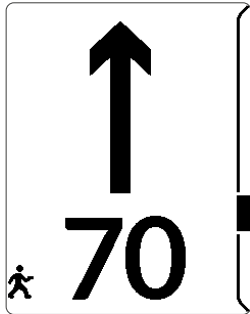

Illustration 19 Signal search pattern with multiple rescuers

3.4.2 Coarse Search

Once a signal is acquired, you enter the coarse search phase, the Barryvox® will show an arrow and a distance indication. Move in the direction of the arrow and the distance indicated will reduce as you near the buried subject.



Screenshot 20 Coarse Search

- When the Barryvox® identifies the first signal you will hear a double beep sound as confirmation. This will help to immediately start to move quickly in the direction of the arrow shown on the display.
- Hold the Barryvox® horizontally in front of you at waist height with an extended arm and keep the transceiver in the horizontal plane. Avoid flipping or twisting the device.
- When a distance of 10 is indicated, slow the search down, take off your skis/snowboard, and proceed on foot. From this distance the beeping sound will repeat faster to differentiate from the search phase >10.
- When the distance indicated goes below 3, you automatically enter the fine search phase (see next section)
- If at any point you lose the signal revert to the strategic signal search as in the previous section, until you find the signal again.

In Complex Situations Slow Down the Search

If the signal of the buried subject you are currently searching for temporarily overlaps with another signal, the device tries to guide you along the optimal search path. If the signals overlap for a long period of time, reliable guidance is limited. The device indicates this with a flashing distance indication and a voice command, "slow down the search". Drastically slow the search until the distance indication stops flashing, this means the signal overlap has cleared.

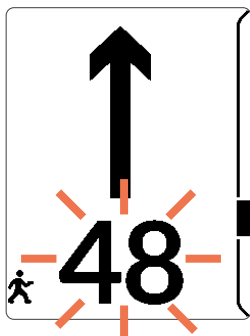

Screenshot 21 Complex Situation

3.4.3 Fine Search

At a distance indication of 3 you enter the fine search phase. By default, the transceiver will enter *Intelligent Fine Search Guidance*. This is a signature feature of the Barryvox® S2 and the only such system on the market. In this mode the transceiver guides you through a cross-search step by step with visual and acoustic guidance. This reduces the complexity and mental pressure during a search, resulting in faster and more efficient rescues.

When entering *Intelligent Fine Search Guidance*, the beeping becomes louder and faster, the closer you get to the buried subject. Slow down the search and hold the transceiver at knee height! Holding the transceiver directly on the snow surface will hinder you in moving steadily on the very uneven avalanche debris. It is crucial that the average height above the snow surface and device orientation do not change during this search phase. The transceiver will warn you if the device orientation deviates from the ideal position. These measures will ensure a precise search.

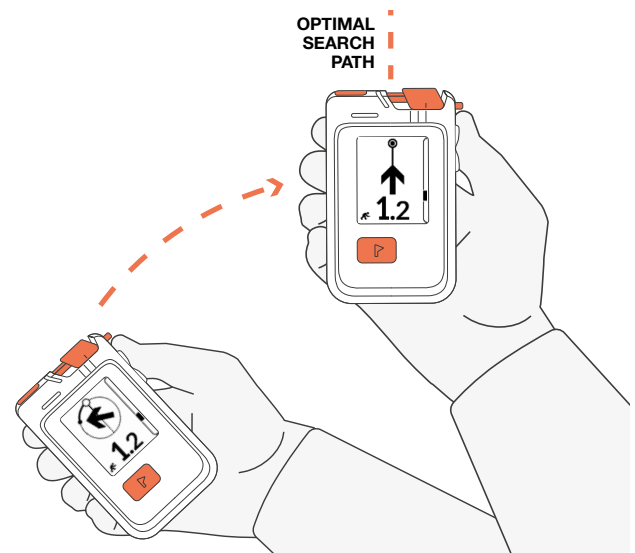

Illustration 20 Fine Search

Using the *Intelligent Fine Search Guidance* you will be fully guided in a systematic cross search pattern to the point where any further search is only faster and more efficient with a probe. This means you will not have to do a manual cross search as you would using any other transceiver. Off-loading this task to the transceiver saves you precious mental resources and time during a stressful rescue situation. For the manual cross search function see "Cross Visual Guidance".

Searching in a strictly perpendicular cross shortens the search time and increases the search precision. For the *Intelligent Fine Search Guidance*, it is mandatory to always proceed to the end of each axis until the Barryvox® tells you to change direction. In case the arrow indicates that you

have deviated from the axis, reorient yourself so that the arrow is in line with the axis.

If you are walking too fast during fine search or in case of a deep burial the transceiver might ask you to repeat the cross search to refine its search precision. The device will guide the rescuer accordingly through one or more fine search crosses. If the distance indication starts to flash, stop moving and wait until it stops flashing.

When the Barryvox® reaches the minimum distance to the buried subject it will instruct you to start probing. This is unlike any other transceivers and eliminates the uncertainty of when and where to start with pinpointing in a rescue. A helpful graphic of how-to layout your probe points is displayed on screen, again reducing uncertainty or errors in the rescue.

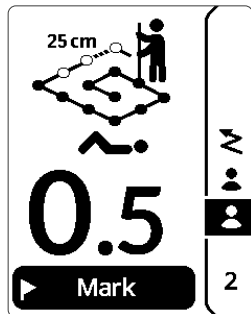

Screenshot 22 Probe indication

Immediately place a marker at the indicated probing point, i.e. a ski pole or hat, at this spot as a reference point from which to start the orthogonal probing spiral, as per [Illustration 22](#) in the next section. Do not use your gloves as a marker, it is important to keep your hands protected during the rescue. Open your backpack now and assemble probe and shovel.

Immediately put your backpack back on, especially if you use an avalanche airbag. In the unusual case of a secondary avalanche, this allows you to take advantage of your safety gear. By strictly keeping your equipment (i.e. first aid kit, radio, or mobile phone) with you in your backpack, you will always have it available when you need it while performing the rescue.

To summarize in the simplest terms the *Intelligent Fine Search Guidance* Proceeds as follows:

1. When the distance indication reaches 3 or below, the device automatically enters *intelligent fine search guidance*, the beeps get louder and faster the closer you get and the graphic on the screen changes
2. The screen will show a dot and a circle, these need to be aligned to be on the correct search path. If needed rotate yourself to align the dot and the circle, [Illustration 20](#). Do not rotate the Barryvox® without rotating your body as well.

3. Follow the arrow on the screen until the Barryvox® tells you to turnaround.
4. Turn around or walk backwards until it tells you to change direction.
5. Move in the direction indicated on the screen. This will be perpendicular to the previous direction, making a cross. Turn around when it tells you to.
6. Move in the direction indicated on the screen until the device gives a probe indication.
7. Mark the location in the snow and start probing.
8. Never press MARK before probing. Only press "MARK" on your Barryvox® if you were able to hit the buried subject with your probe or if you have any other physical assurance of the buried subject.

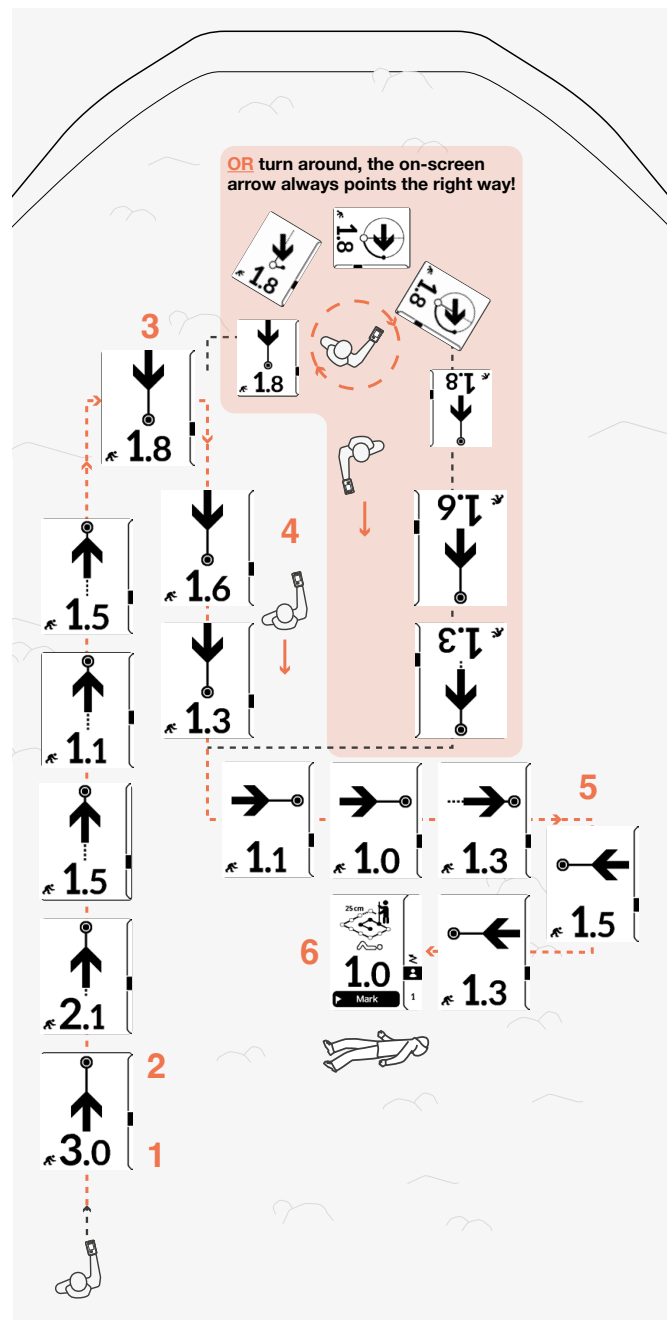
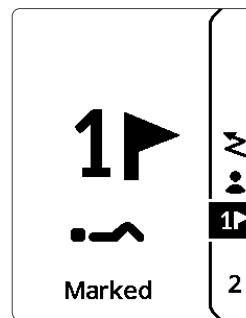

Illustration 21 Intelligent Fine Search

3.4.4 Pinpointing / Probing

Once the probing point has been determined stash the device in **SEARCH** mode on your body (i.e. pocket) so you have both hands available to pinpoint (probe). Begin probing in an orthogonal spiral (*Illustration 22*) at a 90° angle to the snow surface with 25cm between each probing point. If the debris is hard, guide the probe with two hands, one pushing from the top, the other guiding the probe closer to the snow surface to avoid bending the probe. Keep in mind that the remaining distance shown on the screen indicates the maximum possible distance to the buried subject. I.e. if you see 1.1 on the screen, the buried subject must be within 1.1m probing depth and spiral probe radius. In case there is no probe hit within this area, you have missed the buried subject. Repeat probing with a slightly offset probing pattern. If the buried subject is hit with the probe, leave the probe in the snow.



Screenshot 23 *Marked*

Mark the buried subject as found by pressing the Mark button as soon as you have located them using the probe – and only at that point.

If you encounter a particularly deep burial depth, it might not be possible to pinpoint or mark the buried subject. For further information see the section [Deep Burials \(p.39\)](#).

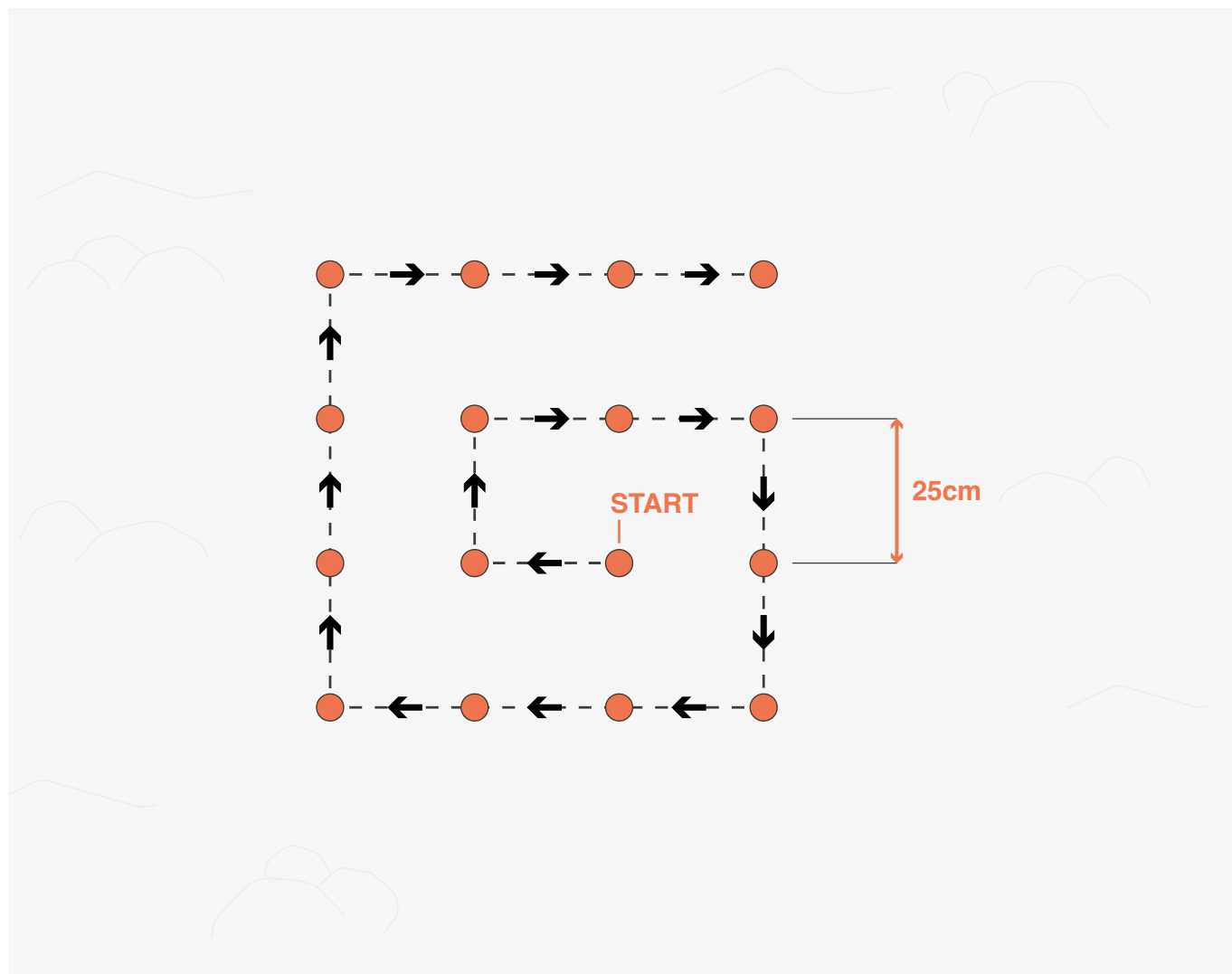

Illustration 22 *Pinpointing pattern*

3.4.5 Shovel

Excavating the Buried Subject

- The first rescuer positions her/himself 1 shovel length (SL) or 1 meter away from the probe
- All following rescuers position themselves 1 shovel length (SL) or 1 meter behind the rescuer in front of him/her
- The first rescuer digs directly at the probe, avoiding any chance of missing it the buried subject
- The following rescuers clear debris, swapping places with the first rescuer after 2-4min. to keep the digging pace high and reach the buried subject as quickly as possible

As with your general emergency plan, the specifics of shoveling will be dependent on how many rescuers are available and other factors. A full discussion on shoveling techniques is out of the scope of this document, and again we recommend further training in this area to optimise your rescue.

3.4.6 Multiple Burials

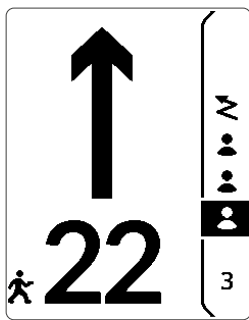

Screenshot 24 Multiple burials

The marking feature allows the search to continue for further buried subjects by marking the located buried subject as found. The marking feature makes the Barryvox® guide you to the next closest buried subject, while non-searching rescuers can dig out the located and already marked buried subject.

Turn off the transceivers of the excavated buried subjects to facilitate the rest of the search. If you don't know the number of buried subjects, you must search the entire avalanche path using the search patterns described in [Signal Search \(p.27\)](#).

Search for Multiple Buried Subjects Using the Standard Search Mode

In standard search mode, the transceiver analyzes all detectable signals and attempts to determine the number of buried subjects. It does this by recognizing the slight differences in the detected signals.

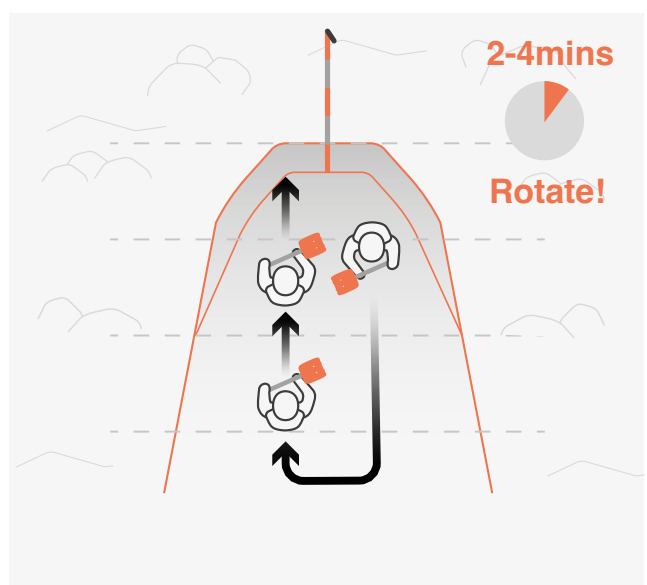
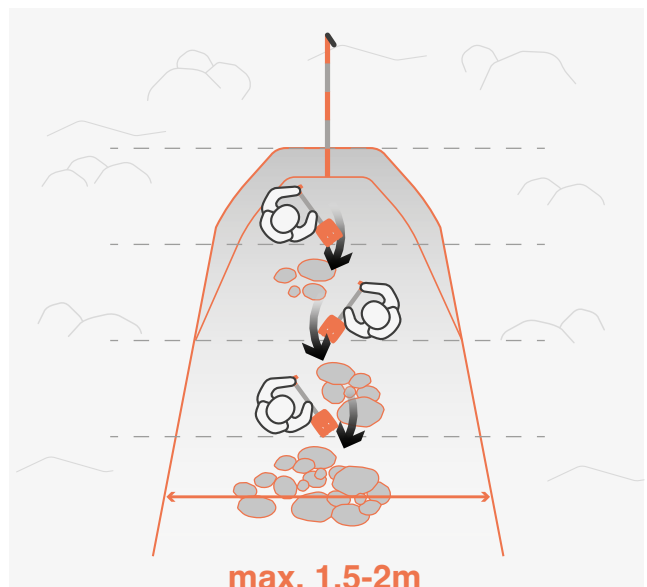
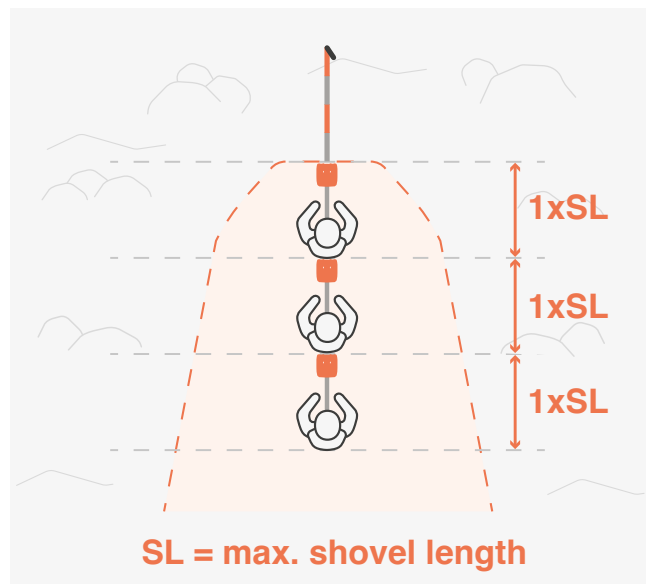

Illustration 23 Shovelling technique and procedure

This is possible because the signals from avalanche transceivers slightly differ from each other. The more the signals differ, the easier, faster and more accurately they can be separated (pattern recognition). By automatically associating the signals with their respective sources, simple multiple burial situations can be solved without applying special search tactics. Barryvox® transceivers, which also transmit information through Bluetooth can be detected particularly quickly and reliably. The Bluetooth information includes a unique identification as well as the transmit (signal) pattern.

Because there are only slight differences in the transmitting signals, signal overlaps can occur. In complex multi burial scenarios it is therefore possible to have strong signal overlaps, which can result in difficulties separating the signals. In this case it is necessary to use Advanced Barryvox® Features and special search tactics to locate all buried subjects.

List of Buried Subjects

The buried subjects whose transmit patterns can be identified are inserted in the list of buried subjects sorted by their signal strength and therefore corresponding with the distance indication. The closest buried subject in the avalanche is shown at the bottom, the furthest at the top of the list. The selection indicator shows the buried subject you are currently searching for. By searching for one buried subject after another and marking them as found, you work through the list of buried subjects from the bottom to the top. Buried subjects already marked as found are shown below the current position of the selection indicator.

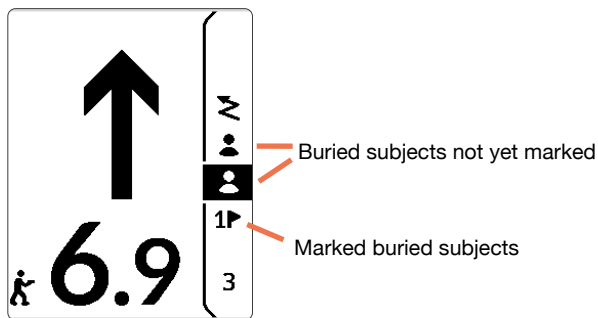

Screenshot 25 List of buried subjects marked

Procedure for Multiple Burials

1. The device favors the closest subject first. Locates the various buried subjects using the transceiver and probe pole.
2. As soon as you mark an individual subject, the transceiver takes to the next closest, unmarked buried subject.
3. Continue this procedure until all buried subjects are located and marked.
4. The rescuer now searches for additional buried subjects while the display changes to indicates the the rest of avalanche surfave must be searched.

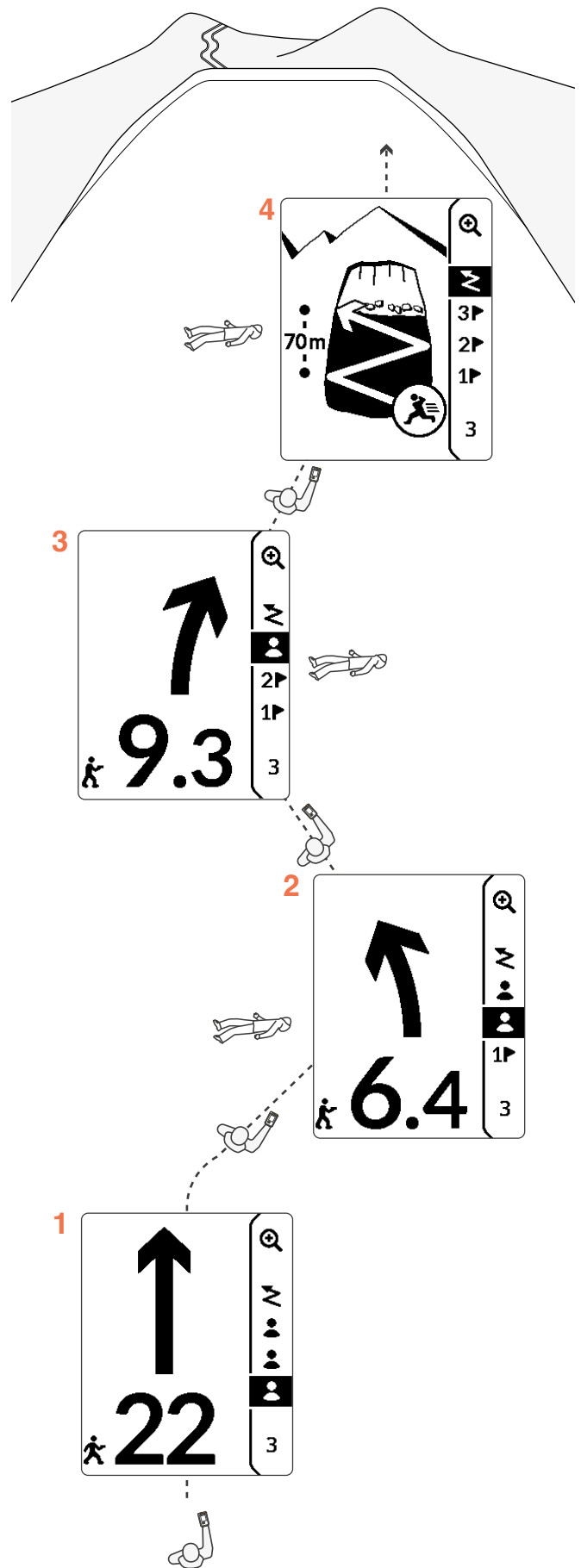

Illustration 24 Multiple Burials

4 ADVANCED BARRYVOX® FEATURES

Digital search has limitations, the larger the number of buried subjects, the more difficult and time-consuming a precise analysis of the situation gets due to overlapping signals. The more signals there are, the longer the signal overlaps can last. The ability to automatically detect and isolate signals from multiple buried subjects in digital mode is therefore limited.

The Advanced Barryvox® Features and foremost the analog search tone help to identify signal overlap and work around them.

4.1 ADVANCED SETTINGS

The factory settings of the device are preconfigured to suite standard user best. For advanced and professional users, it is advised to adjust the settings to best fit their requirements and abilities.

4.1.1 Pro Search

Pro search is an advanced mode that will adjust a number of settings at once which will allow you to:

- hear the analog tone in all search phases in standard search mode
(see [Audio Guidance \(Analog Tone\) \(p.33\)](#)).
- access the Pro Check function within group check
(see [Pro Check \(p.33\)](#))
- scrolling and choosing in the list of buried subjects which allows more efficient group searches and triage decisions
(see [Selecting in the List of Buried Subjects \(p.38\)](#))
- see the vital data of the buried subjects you are searching for to take triage decisions (see [Vital Data \(p.34\)](#))
- access the alternative search mode
(see [Alternative search mode \(p.36\)](#))
- mark deep burials up to a distance indication of 6.0
(see [Deep Burials \(p.39\)](#))
- unmark a buried subject, a mark can be removed by selecting the buried subject in the burial list and selecting "Unmark". You can only remove the mark if you are in the immediate vicinity (<6 m) of the buried subject
- list of buried subjects stays visible (doesn't slide away after 5 seconds) during coarse search

4.1.2 Audio Guidance (Analog Tone)

The setting is valid for all search phases in standard search mode. Choose between analog or digital tone. Analog Tone allows you to identify signal-overlap or other difficulties encountered during multiple-burial searches and helps in resolving demanding search scenarios. It enables you to manually determine or verify the number of buried subjects and differentiate them from any sources of interference (EMI). Analog tone is used for many advanced Barryvox® features. See [Analog Search Tone \(p.36\)](#).

Digital tone offers supplementary acoustic guidance by raising the volume and increasing the repetitions of the beep sound when you get closer to the buried subject and vice versa. This leads to a more intuitive and easier search. With digital tone you will not be able to hear multiple signals as with analog tone.

4.1.3 Fine Search Guidance

Choose between "Guided" or "Cross" guidance for the fine search phase.

"Guided" is the standard setting with animated search support and intelligent fine search guidance enabled. This provides extremely user-friendly search instruction for fine search phase and fully guides you to the phase where you start pinpointing. (see [Fine Search \(p.28\)](#))

"Cross" will enable a simplified user interface to perform a non guided fully manual cross search during the fine search (see [Cross Visual Guidance \(p.39\)](#)).

4.1.4 Pro Check

The "Pro Check" verifies the transmission frequency, the period and pulse duration of the tested device (see [Using Pro Check \(p.34\)](#)).

4.1.5 Auto-Revert SEARCH to SEND

The Auto-Revert **SEARCH** to **SEND** function switches the device from **SEARCH** mode to **SEND** mode if there is no user interaction or major motion for a specific amount of time.

In case of a secondary avalanche burying rescuers or a device being unintentionally left in **SEARCH**, this function increases the chance of being found in time. This function is critical for your personal safety! If you disable this setting, you will see the warning symbol during signal search in **SEARCH** mode.

4.1.6 Auto Revert to SEND timeout

This allows the user to define how long the transceiver waits before switching back to **SEND**. This setting defines the timeout for Auto Revert **SEARCH** to **SEND** as well as **RESCUE SEND**.

The default setting of 4 minutes is appropriate for most users, shorter times tend to lead to more frequent, involuntary switchovers. Rescuers that inadvertently switch to **SEND** mode may cause severe distraction to an ongoing search, only change this setting if you have an important reason to do so.

4.1.7 Vital Data

Your Barryvox®S2 detects slight motion of the body, such as a pumping heart or breathing lungs. Any motion is interpreted as a vital sign, for further information on vital data see [Vital Data \(p.34\)](#). While you are buried, the device transmits your vital data via the Vital Data BT connection to the rescuers (default setting). In **SEARCH** mode, the

Barryvox® displays the vital status, provided the sender has enabled Vital Data BT and the ability to transmit vital data. If you do not wish to have these data transmitted, you can disable this feature. Utilizing vital data as one triage criteria can increase the ratio of survival in a search where rescue resources are stretched – for this reason only change this setting if you have an important reason to do so.

4.2 USING ADVANCED FEATURES ON TOUR

4.2.1 Using Pro Check

The “Pro Check” analyzes additional parameters of the tested transmitter and displays them. In case a measured value is out of tolerance, an alert is shown for the respective parameter. We especially recommend performing the “Pro Check” on older 1- and 2- antennae devices and in general for devices which have not been tested by the manufacturer for a prolonged period of time. The “Pro Check” function must be turned on in the “Pro Settings” (see [Advanced Settings \(p.33\)](#)).

The Pro Check verifies the transmission frequency (Freq: deviation +/- in Hz from 457'000 Hz), the period duration (Period: duration of the period in milliseconds ms) as well as the pulse duration (Pulse: duration of the signal in milliseconds ms) these parameters are discussed in more detail

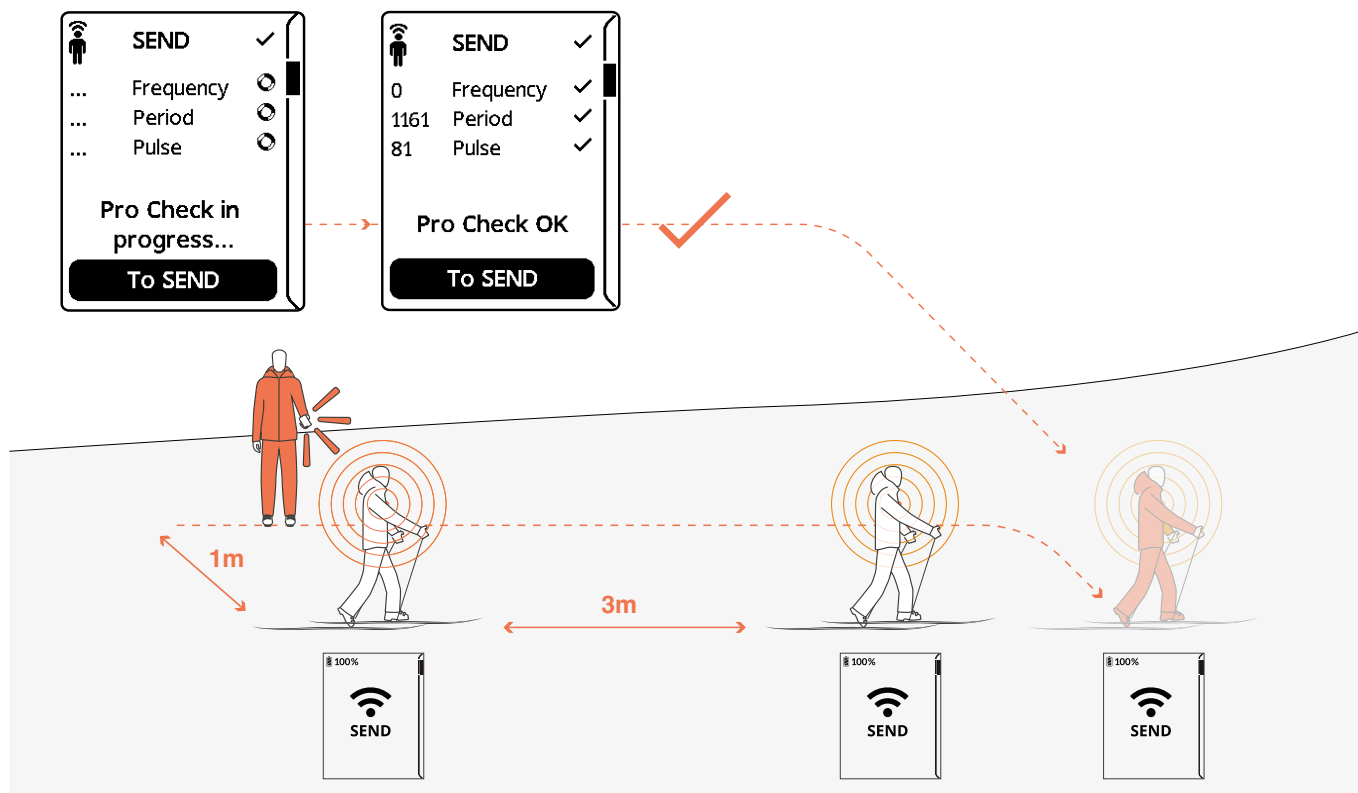

Illustration 25 Pro Check 1

below. The device that needs to be tested is set to **SEND** mode, the distance between the participants must be increased to 5m for the pro check. The group leader activates group check on his device and scrolls down with the side button to the function “Pro Check”. Wait until the device has performed the test and the test results are shown. To increase the measurement accuracy, hold both devices vertically while performing the “Pro Check”.

Please be aware that the measurement accuracy of an avalanche transceiver does not match the accuracy of test- or laboratory equipment and that the “Pro Check” cannot replace the periodic check of the transceiver by the manufacturer.

In case the “Pro Check” discovers problems, the tested device should not be used and must be checked by the manufacturer (see [Service and Maintenance \(p.14\)](#)).

How to Interpret the Parameters Measured by the Pro Check

All avalanche transceivers worldwide adhere to the same legal standard, or “norm”. This ensures compatibility between all transceivers worldwide; thus every transceiver can be searched for and found by others, regardless of the transceiver brand and model. Although all manufacturers operate under the same standard, there are still many older transceivers in use and every manufacturer applies slightly different transmission parameters within the legal framework, but they will all still work. Some differences between individual signals, in particular in the pulse rate, is even an advantage in multiple burial situations as it reduces the likelihood

of persistent signal overlap. At the same time, each different signal can create different scenarios when in combination with various other transceivers. The three parameters tested in Pro Check are defined by the international norm for avalanche transceivers (EN300718).

A Frequency deviation:

The transmission frequency of an avalanche rescue transceiver is 457kHz. The legal standard allows a tolerance of +/- 80 Hz. For additional safety, the Barryvox® digital signal processor receives a wider range of frequencies than the norm specifies. A transceiver that is out of transmission frequency tolerance always leads to a lower probability of detection and thus unnecessary complexity and uncertainty when your life depends on every minute! As devices often shift out of tolerance over time and not suddenly, features like Pro Check may be used to detect developing problems before they have a serious impact.

B Period duration:

This is the duration of a full cycle of one pulse [“on time”] plus the time (pause) in between transmitted signals [“off time”], it is measured in milliseconds (ms). The norm is 1000ms +/- 300, or 700ms - 1300ms. There is a risk that a period under or over the norm length could be interpreted by the searching beacon as “not a signal from an avalanche transceiver” or even as “two signals” (although you would still hear the analog tone with Pro Search activated). Also of note, a signal with a shorter period will always cause overlap more frequently than one with a longer period when in combination with any other transmitter, especially in combination with a longer pulse.

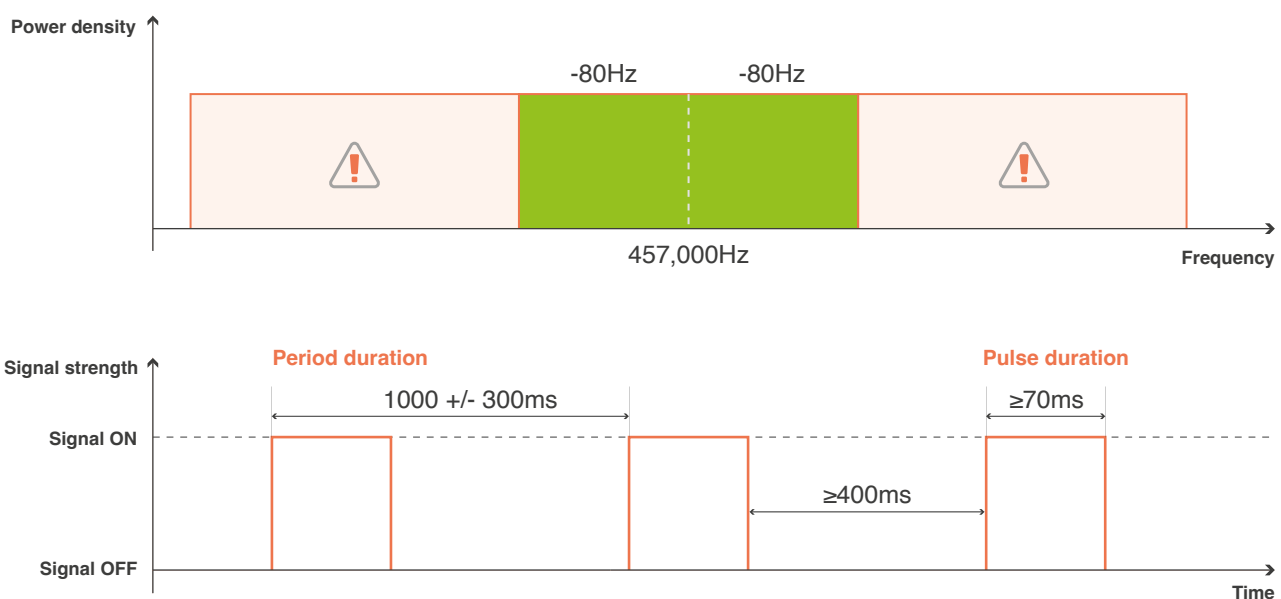

Illustration 26 Frequency deviation, Period and Pulse Duration

C Pulse duration:

This is the length of time that each transmitted signal lasts – the [“on time”]. The norm dictates the pulse must be a minimum of 70ms. Very long-lasting pulses, that you would see with older analog-only transceivers, result in more frequent and more long-lasting signal overlaps when in combination with any other transceiver. This means that having one older transceiver with a long pulse in your group can make searching more difficult for every other transceiver in that group should they become buried within range of each other. On the other hand, a pulse shorter than the required 70ms minimum doesn't allow sufficient signal acquisition time for the searching transceiver, which may lead to issues like inaccurate distance and direction indication or even failure to be recognized as a signal by another avalanche transceiver.

4.3 USING ADVANCED FEATURES IN A RESCUE

4.3.1 Analog Search Tone

The analog tone helps you detect overlapping signals or other issues when searching for multiple buried subjects. This way, you know when to switch to a different search method, such as micro search strips, micro box, or the 3-circle method.

During the Signal Search, hold the beacon close to your ear and slowly rotate it to match the X, Y, and Z axes to get the maximum range in all directions. Be aware of electromagnetic interference (EMI) and pay attention to any warnings. Use the full width of your search strip for maximum efficiency.

Since the analog signal is received by only one antenna, the distance shown on the display and the tone volume will only match when the receiver and transmitter antennas are optimally aligned. The transceiver automatically adjusts the analog tone volume, so rely on the distance indication on the display to determine your **absolute proximity** to the buried subject. Additionally, the analog sound allows you to estimate the **relative distances** of buried subjects to each other.

Furthermore, if your Barryvox® directs you to a beacon that isn't the closest due to signal overlap, you can verify this by checking the analog tone.

4.3.2 Electromagnetic Interference and Analog Tone

Interference is predominantly caused in busy areas like ski resorts or when you are searching with a radio or other electronic equipment turned on in parallel. In these situations, you may benefit from the analog tone which will help

you distinguish between “false positives” and “real” signals. Misleading direction and distance indication are called “false positives” or “ghost signals”

Detecting Interference

To differentiate between the signal of a buried subject and false positives, listen for the analog sound. An authentic signal will produce an analog sound approximately every second for every transmitter in proximity, along with a distance and direction indication. If you see a distance and direction indication, but hear no or infrequent analog sounds, it is likely a false positive.

In cases of severe interference, i.e. power lines or ski lifts in close proximity, use alternative search mode and reduce search strip width

4.3.3 Alternative search mode

When to Switch to Alternative Search Mode:

- 1. Detection Problems:** If you notice issues with the digital signal analysis during a multiple burial situation, switch to the alternative search mode. This will delete the current list of buried subjects.
- 2. Discrepancies:** If your understanding of the avalanche (your “mental map”) doesn't match the transceiver's indications, it means the standard mode can't locate all buried subjects. Switch to the alternative search mode, which is better for strategies like micro search strips, the micro box, or the 3-circle method.
- 3. Interference:** Use the alternative search mode in areas with heavy disturbances or interference when problems arise.

To enable this mode, use the “Up-Button” to scroll to the magnifying glass symbol in the list of buried subjects. Then select “Alternative” by pressing the “Mark Button”.

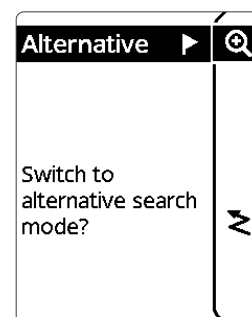

Screenshot 26 Alternative Search Mode Menu

In the alternative search mode, the transceiver shows distance and direction to the subject with the strongest signal. The list of buried subjects will not be shown anymore.

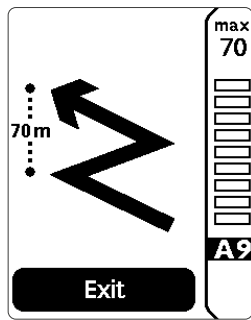

Screenshot 27 Alternative Search Mode Signal Search

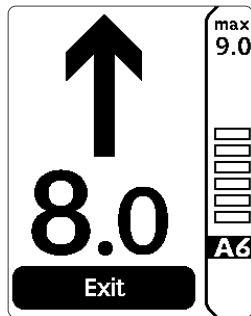

Screenshot 28 Alternative Search Mode Distance and Direction

Leave alternative search mode by pressing the Mark button.

Multiple Buried Subjects in Alternative Search Mode

If multiple burials are detected in alternative search mode, an icon symbolizing multiple burials is shown on the display. Additionally, you will also hear the analog tones. These are helpful in distinguishing the signals acoustically. When automatically switching gain levels the device favors the closest subject. The detection of multiple burials may vary based on the subject's orientation and distance relative to the rescuer.

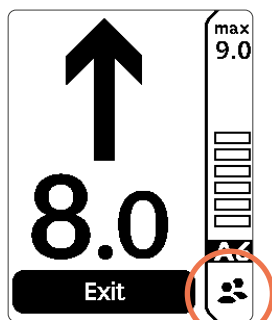

Screenshot 29 Alternative Search Mode Multiple buried subjects

Automatic or Manual Amplifier Mode (Volume / Gain Level / Sensitivity)

The volume, gain level and sensitivity of the Barryvox® all refer to the active gain level of the amplifier within the Barryvox® signal processing unit. Changing the amplifier gain level adjusts the sensitivity for receiving signals which directly affects the volume of the analog tone through the speaker. The Barryvox® adjusts the gain level of the amplifier automatically and is dependent on the strongest signal (default). In alternative search mode the gain level can be adjusted manually if required, by pressing the side buttons of the Barryvox®. Up increases and down decrease the gain level.

The active automatic sensitivity level is indicated by the letter "A" followed by a single digit at the bottom right side of the screen or the count of empty bars above the letter "A". A9 is the highest and A1 the lowest sensitivity, respectively. The active manual sensitivity level is indicated by the letter "M" followed by a single digit at the bottom right side of the screen or the count of solid black bars above the letter "M". M9 is the highest and M1 the lowest sensitivity, respectively. In manual mode the maximum possible range of each gain level is written in the top right corner of the Barryvox® display, see screenshot.

Gain Level	Maximum Range
M9	70
M8	30
M7	15
M6	9.0
M5	4.5
M4	3.0
M3	1.5
M2	0.9
M1	0.6

Table: M9 receives the greatest and M1 the shortest distance to a buried subject.

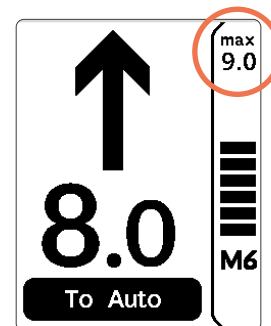

Screenshot 30 Alt. search mode volume control, max range

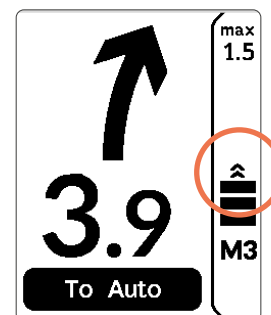

Screenshot 31 Double arrow unreliable distance indication

If the sensitivity is set too high or too low, the distance and direction indications become unreliable. The distance indication will flash, and a double arrow symbol (see screenshot) prompts the user to adjust the volume. Press the "MARK" button to return to automatic volume control.

4.3.4 Sound Check

“Sound Check”

The analog tone is a very useful and important tool to determine the number of buried subjects reliably in complex rescue situations: Counting the number of beep sequences lets you determine the number of buried subjects.

1. Do I hear only ONE beep sequence?

Yes: only ONE buried subject received by the Barryvox®
No: at least TWO buried subjects received

2. Do I hear only TWO beep sequences?

Yes: only TWO buried subjects received
No: at least THREE buried subjects received

3. Do I hear only THREE buried subjects?

Yes: only THREE buried subjects received
No: at least FOUR buried subjects received

The number of beep sequences / buried subjects needs to be interpreted in conjunction with the distance indication / sensitivity level of the Barryvox®.

Example: You hear three different beep sequences, and the distance reading shows 3.0. Therefore, three buried subjects can be expected within a radius of approx. 4.5 m (indicated distance + ~50%). Always apply the “Sound Check” at the distance indication of 10 and 3.0!

Mental Map of the Burial Situation

The “Sound Check” provides the required information to build up the “mental map” of the burial scenario, which is critical base information for determining the best search strategy.

Knowing the number of buried subjects within a given distance from yourself (rescuer) and from each other allows the rescuer to determine when an alternative search strategy is required due to signal overlap or other difficulties, versus when the standard search mode can continue to be used.

4.3.5 Selecting in the List of Buried Subjects

When the search is conducted with multiple rescuers searching at the same time, avoid searching for the same buried subject as another rescuer to save time. Use the side buttons, to choose (scroll the list) which buried subject you are searching for from the list of buried subjects.

Situation 1: Two rescuers detect two buried subjects

While one rescuer continues to search for the buried subject closest to them, the other rescuer can search for the second buried subject, without having to mark the first buried subject. By pressing the “DOWN” button, the second rescuer can select the second buried subject that is slightly further away and will be directed to their location.

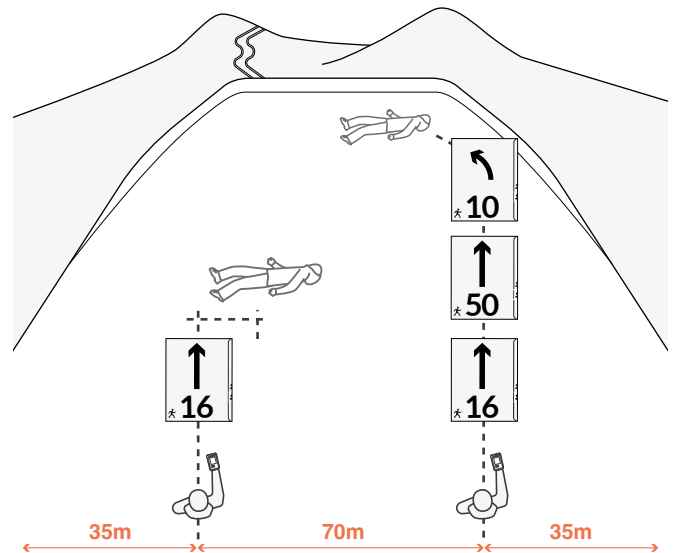

Illustration 27 Multiple rescuers 1

Situation 2: Two rescuers only detect one buried subject

One rescuer continues the search for the buried subject closest to them, the other rescuer should search the remainder of the avalanche path for more buried subjects. When they press the up button, the selection indicator is now on -signal search. The signals of the buried subjects who are already in the list of buried subjects are now ignored.

The device is now searching for buried subjects who are not yet in the list of buried subjects and leads the rescuer to those as soon as a new signal is detected.

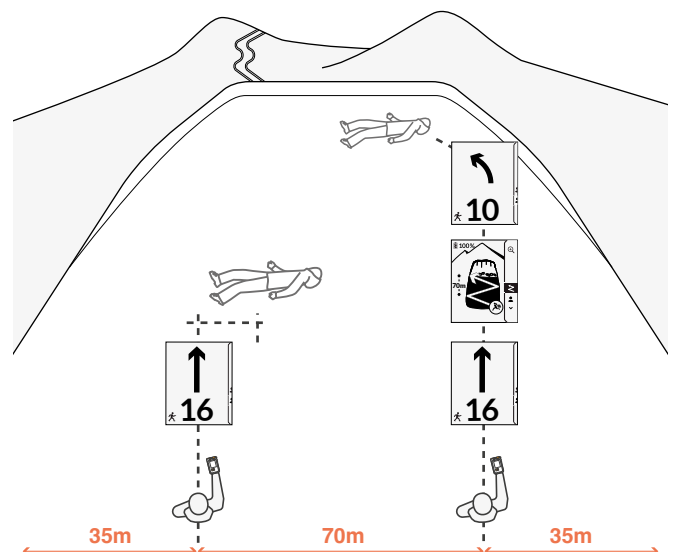

Illustration 28 Multiple rescuers 2

4.3.6 Cross Visual Guidance

The “cross” mode, shows a simple user interface and the fine search is carried out by manual bracketing, requiring the user to be attentive to the distance indicator and aware of the procedure for a successful fine search. The user must take note of the maximum and minimum values indicated on the screen themselves and use this to decide the probing point. I.e. moving the transceiver slowly and steadily and in perpendicular axis to find the minimum.

4.3.7 Deep Burials

The transceiver tries to detect deep burial depth and, if required, dynamically increases the fine search range. Marking a buried subject at a depth greater than 6 meters is not possible. If the buried subject cannot be located by the probe, place the probe approximately 1.5 meter above the point with the lowest distance indication. While shoveling, more space will be made available to allow for further fine search and pinpointing within the excavated area.

4.3.8 Burial Data

In case of a burial, the victim’s transceiver records the burial duration and detects “vital data”. This is useful information for first responders, as it helps to assess the condition of the victim. It can be accessed by pressing “down” on the side button when the transceiver is in SEND mode. Total burial duration is displayed at the bottom in hours and minutes along with how long vital data was detected for on top.

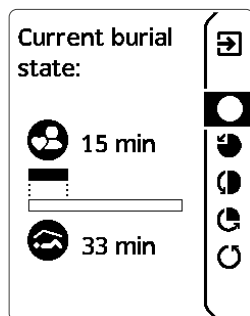

Screenshot 32 Burial data

In case the device of the buried subject was immediately switched off when it was found, or the patient was moved (i.e. transported) over a longer period of time, you can find the burial data of the four last resting periods of the transceiver by scrolling down with the side button and opening the burial data overview. The resting periods are in chronological order:

- Current recent resting period
- Last resting period
- Second last resting period
- third last resting period
- oldest resting period

4.3.9 Vital Data BT & Triage

Triage

With limited resources (few rescuers) it is not possible to locate and dig out all the buried subjects at the same time. The question arises in which order the buried subjects should be rescued.

Subjects with higher chances of survival should be located and dug out first. Besides simple terrain factors, e.g. a drop over a cliff, over seracs or in crevasses, collision with trees etc., the burial depth and vital data are important triage criteria.

Vital Data BT

If too few rescuers are available to simultaneously search and dig out all buried subjects, “Vital Data” can be used to prioritize buried subjects with “increased survival chances”. In the list of buried subjects, each buried subject with “increased survival chances” is labeled with a “heart-icon”, see screenshot. With the Barryvox® in SEARCH mode, use the “UP” or “DOWN” button to navigate to buried subjects with “increased survival chances”. Use the “MARK” Button to select a buried subject with “increased survival chances”.

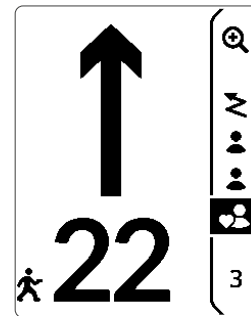

Screenshot 33 Buried subject vital data

The actual prioritization of certain buried subjects over others is up to the rescuer. We strongly recommend that Vital Data is relied upon only when a fleet of Barryvox®S2 or 2 transceivers is used. To use with “Vital Data BT” you need to switch it to “ON” in the “Advanced Settings”.

Vital Data Detection

The Barryvox®S2 and Barryvox®2 contain highly sensitive sensors that can detect slight body motions, such as a pumping heart or breathing lungs. Any motion within a certain time is interpreted as vital data. The data is detected on the buried subject’s transceiver and sent across a Bluetooth connection to the transceivers of the rescuers. A buried subject with a “heart-icon” indicates a higher chance of survival. It can be assumed that buried subjects that have survived the first 35 min are still able to breathe (air pocket), and therefore have increased chances of survival. At the same time, the detectability of vital data decreases due to hypothermia. Therefore, buried subjects who have transmitted vital data for the first 35 min are considered to have high

chances of survival for the rest of their burial duration even if no vital data is detected anymore.

Based on the list of buried subjects, the rescuer decides in which order he will locate and dig them out. Using vital data as a triage criterion shortens the burial duration for those subjects having higher chances of survival. This improves the overall rescue efficiency.

The range of Vital Data BT depends on terrain and body interference, the physical characteristics of the avalanche debris and the orientation of and distance to the buried subject and can therefore vary.

Limitations of Vital Data BT Detection

The new Vital Data BT uses Bluetooth technology to communicate. It is NOT compatible with the older W-Link technology of the Barryvox® S and Pulse Barryvox® generation. The sending and receiving units must be Barryvox® S2 or Barryvox® 2 devices for the Vital Data BT functionality to work.

All buried subjects, whose transceivers are technically not capable of detecting vital data or unable to detect any, belong to the “unknown” chances of survival category and do not have a “heart-icon”.

If you carry the transceiver in a trouser pocket instead of the Barryvox® Holder at your chest, the detection of vital data may not be possible due to the almost non-existent body motions.

The vital data does not provide any assessment of the health of the buried subject. It does not substitute an assessment by medically trained personnel (physician).

4.4 ADVANCED SEARCH STRATEGIES

The following search strategies are extremely advanced techniques requiring professional training. The descriptions below offer only brief overviews, and we highly recommend further training before using any of these techniques.

4.4.1 Search Tactics with Multiple, Widely Scattered Burials

1. Mark the location on the avalanche where the “multiple burial” icon appeared on the display or where you left the signal search pattern.
2. Search for the first buried subject using the information on the display along with the analog tones. Once this subject is located, you or other rescuers should dig them out immediately.
3. Continue to search for other buried subjects by returning to the previously marked point.
4. Strictly adhere to the signal search pattern and continue down the avalanche path until you are led to the next subject. Initially, the transceiver will want to take you to the previously located subject, because they are still the closest. Ignore these indicators until you notice that the transceiver is pursuing a new subject.

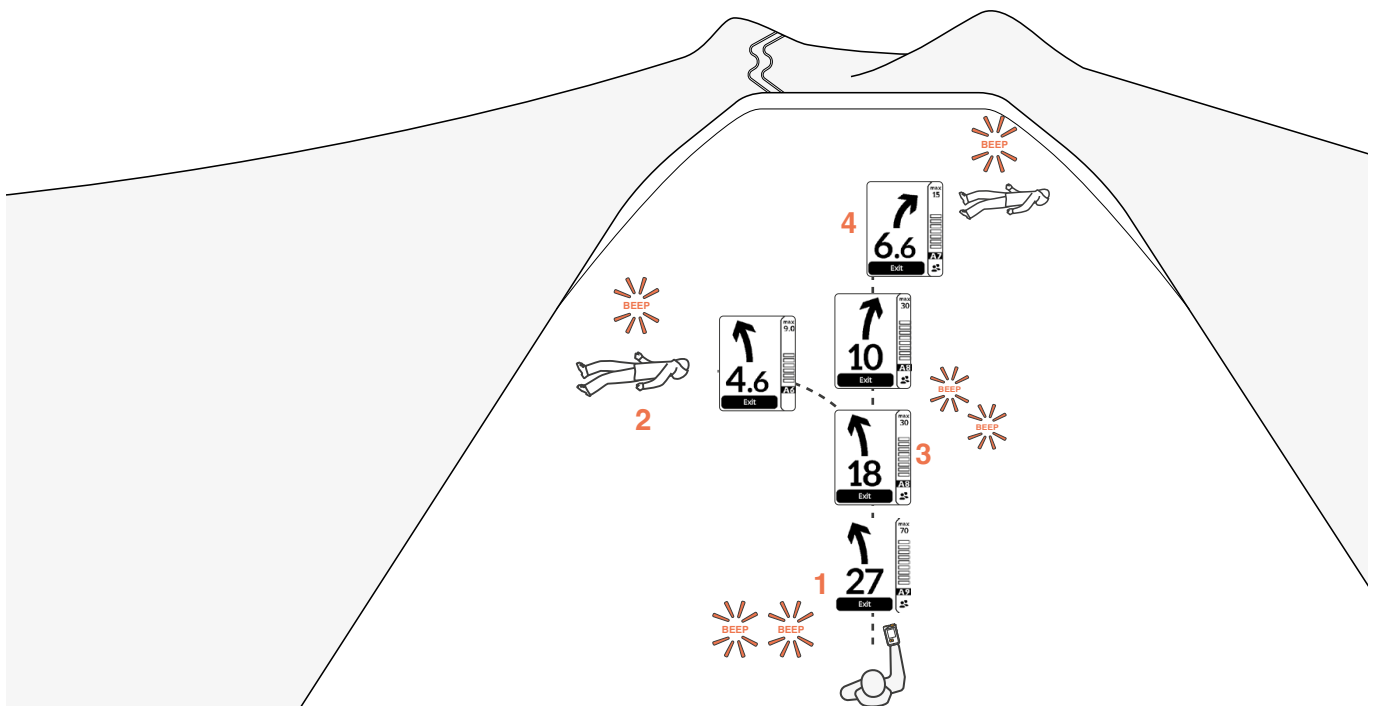

Illustration 29 Search tactics with multiple widely scattered burials

4.4.2 Search Tactics with Multiple Burials in Close Proximity

Interpreting Sound Checks

Analog Sound Checks act as a “Checks and Balance” to help the rescuer identify absolute possible distances of targets. This is especially useful in extreme cases of EMI and/or Signal Overlap, in which case the signal separation algorithms of the Barryvox® may not have enough information to accurately identify which target is closest or how many exist. This can lead to a missed target or a direction indication which is not, in fact, the closest buried subject.

While Sound Checks can be performed at any point in the search, best strategic practice is to consistently perform checks at indicated distances of 10 and 3. This ensures the rescuer does not need to re-interpret the readings at various locations.

Analog “gain” (volume + range) is automatically reduced as you approach a target. Any time multiple analog tones are heard at 10m, the rescuer can have confidence that the range of the analog tones is no more than 150% of the reading on the screen (15). All discernable tones are within 15m in any direction.

Any time multiple tones are heard at 3m, the rescuer can have confidence that the range of the analog tones is no more than 4.5m—which indicates a close proximity burial configuration.

Image 1 (10m Sound Check):

The first Sound Check is always performed at 10m. When multiple tones are heard at 10m, the first victim is no more than 10m away and the second victim is no more than 15m away.

Image 2: (3m Sound Check, situation 1)

The second Sound Check indicates no more than 1 tone. This confirms that the second victim (heard at the first 10m check) is now out of range. Rescuer now knows 1 victim is within 3m, and the second victim is outside of the 4.5m range—they are not extremely close together.

Image 3: (3m Sound Check, situation 2)

The second Sound Check indicates that there is still more than 1 target. Both targets are within 4.5m—Rescuer has a close proximity rescue at hand.

Any time an alternative search strategy needs to be selected for targets that are not extremely close (NOT within 4.5) the proper selection is [Micro search strips \(p.42\)](#)

Any time an alternative search strategy needs to be selected to solve an extremely close proximity rescue (multiples within 4.5) the answer is [Micro box \(p.43\)](#)

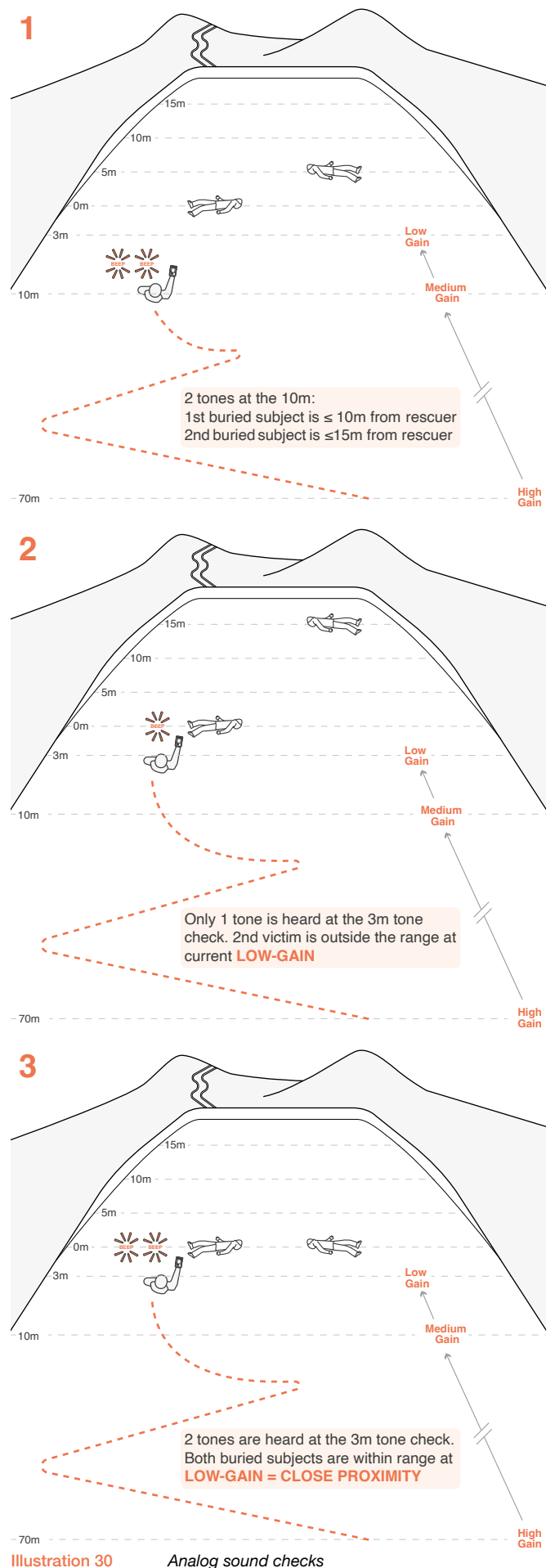

Micro search strips

If you have multiple burials within an indicated distance of 10 or less, search using micro search strips.

1. Locate the first buried subject.
2. Back up until the display shows 10 and search the area in front of you in parallel search strips.
3. As soon as the distance reads 10, you have reached the side of the search strip. Advance 2 to 5 meters and return on the next parallel search strip until this search
4. strip ends as well (distance indication > 10).
5. Maintain the perpendicular orientation of the transceiver to the microstrip during this phase and concentrate on the increase or decrease of the distance indication as well as the number of the analog tones.
6. At the lowest distance reading, leave the micro search strip pattern to fine search the buried subject through bracketing. At the lowest indicated distance on a micro search strip, always check by bracketing behind and in front of you for further buried subjects. As burial depth is

unknown, every low point in distance indication must be checked! Once the subject is located, return to the location where you left the search strip to continue the pattern.

7. The more buried subjects there are and the closer these are, the tighter the micro search strip grid on the potential search area should be. As a rule of thumb, the search strip should be between 2 and 5 meters wide.
8. Continue the pattern, until the distance reading in an entire strip never drops below 10. Then revert to the signal search pattern and search the rest of the avalanche. As long as the signals of the buried subjects you have just found in the micro search strips are audible, only apply 50% of the regular signal search strip width. Exit alternative search mode and use full search strip width when those signals have faded out by distance.

The avalanche probe is very helpful in locating multiple buried subjects in close proximity

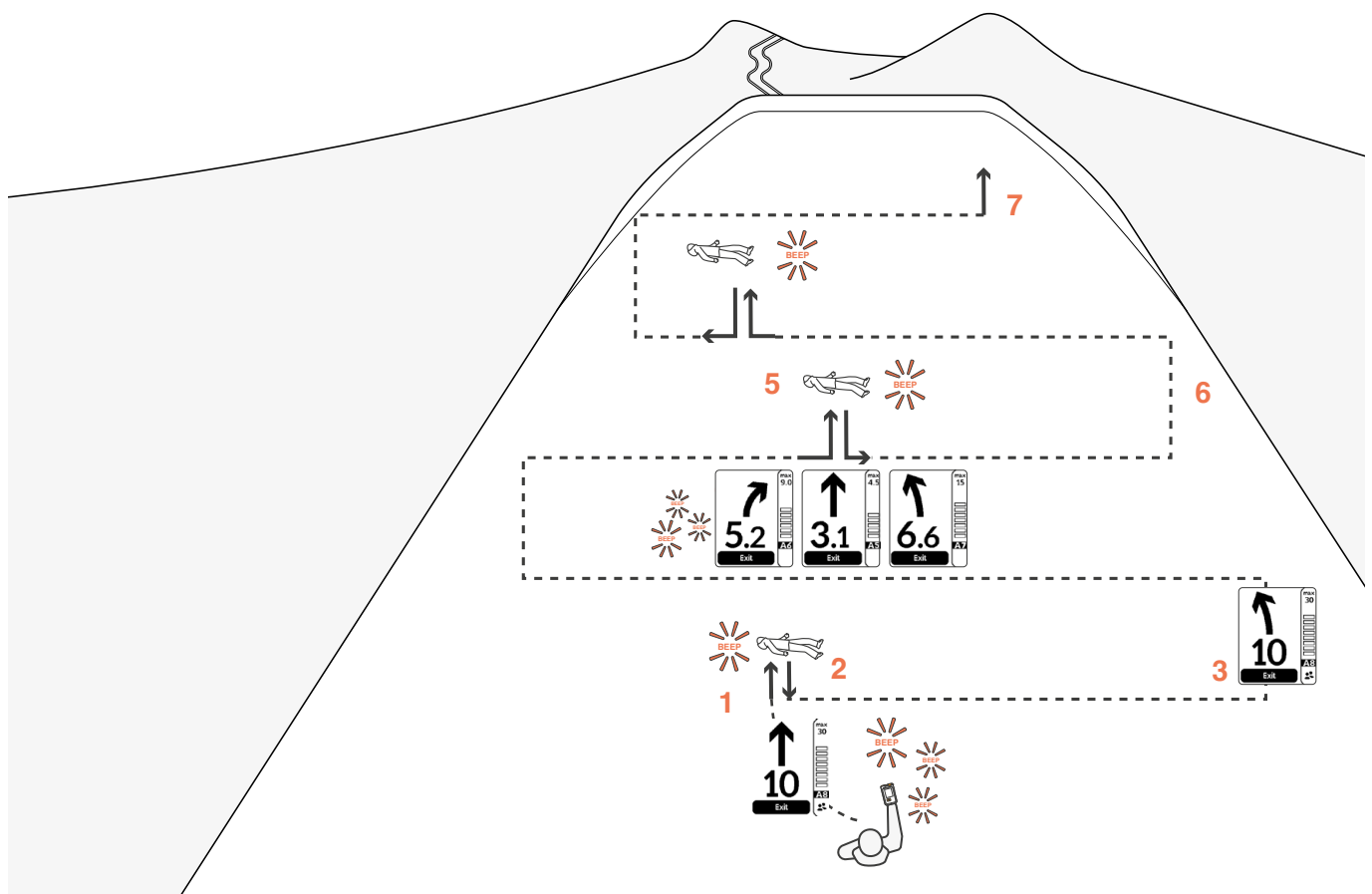

Illustration 31 Micro search strips

Micro box

The Micro-Box method is used when there is more than one buried subject within fine search range. In these very close proximity cases, the micro search strips (or the 3-circle method) may not provide a sufficient resolution to reliably separate and thus detect all of the closely buried subjects. Apply the micro-box when more than one sound is audible at the sound check at distance 3.0. Find the point of lowest distance to the closest buried subject and visually mark that spot. Then, slowly back up, holding the device as close to the surface as possible until the second tone can be heard – this is the range at which to conduct the box search. Holding the transceiver in the same orientation and on the snow surface, walk a square (box) around the marked spot (centre) maintaining that range, until the distance indication changes to show the signal has jumped to the second transmitter.

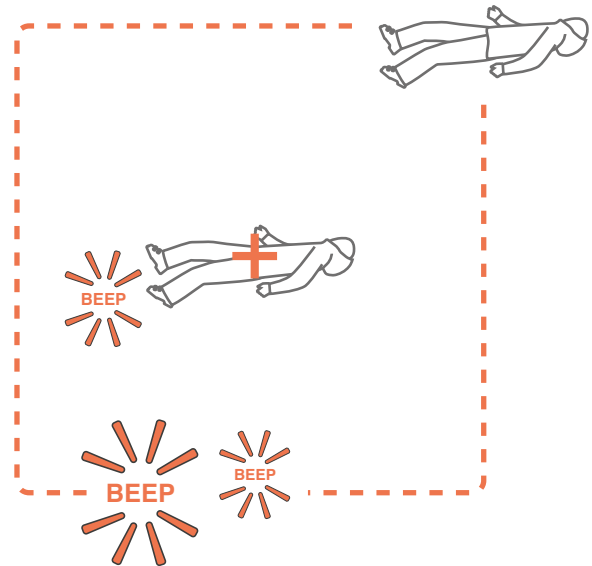

Illustration 32 *Micro box*

From there the second subject is located using a traditional bracketing method. In case there is no second distance low point indication in the box, the second buried subject might be below the first. Probe the surface of the micro box with full probe length-

The 3-circle method

The 3-circle method uses concentric, circular search strips with radiuses of three, six, and nine meters around the first located subject. As with the micro search strips, the locations with the strongest signal strength are of interest. From there the subjects are located using a traditional bracketing method

Tip: Use the probe length to help determine the 3 radiuses around the first located subject. The transceiver should remain parallel to the circle around the first located buried subject.

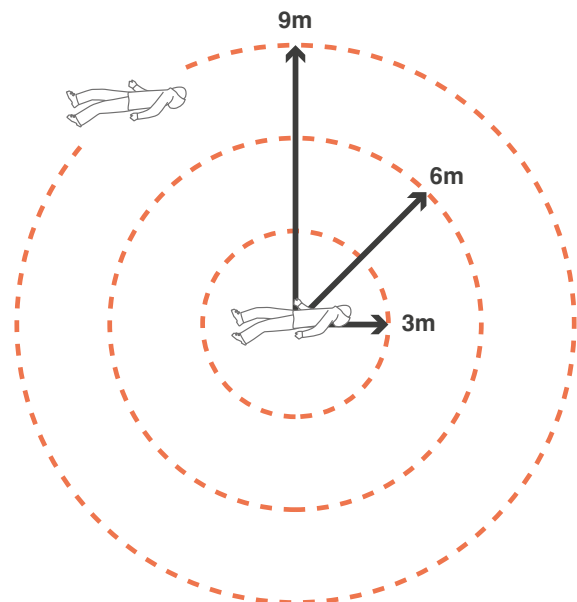

Illustration 33 *3 circle method*

5 FLEET MANAGEMENT AND SERVICE INFRASTRUCTURE

5.1 MAINTENANCE SOFTWARE

Use in combination with the Barryvox® Maintenance Software

The Barryvox® Maintenance Software allows the user to efficiently manage, configure and maintain transceiver fleets with a computer. The Barryvox® S2 and Barryvox® 2 are able to automatically connect to a service device (Barryvox® Tester or Barryvox® Bluetooth Stick) within Bluetooth range. The reliable Bluetooth range inside a building is approximately 15m. In optimal conditions outside the Bluetooth range can approximately 50m. In service mode, the serial number is shown on the screen. While in service mode, the **SEND** mode is deactivated, and the red LED is double flashing.

The Maintenance Software offers the following features:

1. **Update Firmware:** Bring the device up to date.
2. **Device Configuration (Settings):** One device for all needs (beginner, professional, rental device, organizations).
3. **Load Custom Startup Image:** Custom appearance (rental devices, organizations (marketing, theft prevention)).
4. **Fleet and Quality Management:** Management of multiple devices (configurations, etc.). Check self-test, battery (logging).
5. **Function Test:** Device test (function check) (Recommendation: every 3 years). Organizations often annually.

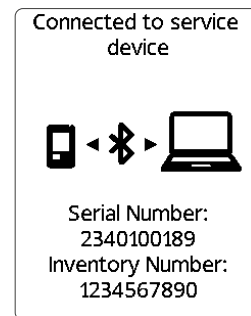

Screenshot 34

Maintenance Screen Barryvox®

THE ESSENTIAL FOUR

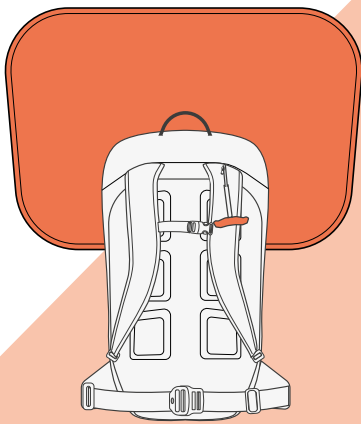

[SHOP AIRBAGS ↗](#)

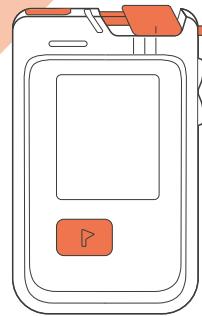

[SHOP TRANSCEIVERS ↗](#)

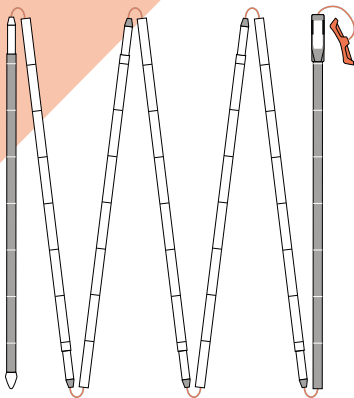

[SHOP PROBES ↗](#)

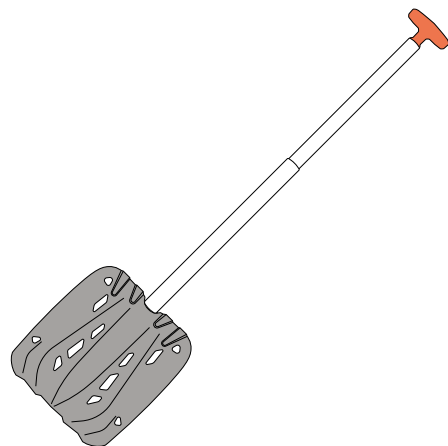

[SHOP SHOVELS ↗](#)

MAMMUT®